

All Linear kits include your choice of low voltage lighting

Lumina 1 Spotlight



Lumina 3 Spotlight



Lumina 7 Spotlight



Lumina 8 Spotlight



Tabletop Graphic Mounting Kit

lifetime warranty



spare pieces to mount wings to tabletop Linear displays

MSRP \$60.00

code LN-TT-G-HDW-K

Trade Price (Hardware)

Advance d

\$50

Linear Tabletop Kit AA	
lifetime warranty	
Complete Hardware Kit	
code	LN-K-TT-AA
MSRP	\$800.00
Advance d	
\$750	
Complete Printed Graphic Set	
X	
code	LN-K-TT-AA-G
MSRP	\$500.00
Advance d	
\$369	

Linear Tabletop Kit BB	
lifetime warranty	
Complete Hardware Kit	
code	LN-K-TT-BB
MSRP	\$800.00
Advance d	
\$750	
Complete Printed Graphic Set	
X	
code	LN-K-TT-BB-G
MSRP	\$500.00
Advance d	
\$369	

Linear Tabletop Kit CC	
lifetime warranty	
Complete Hardware Kit	
code	LN-K-TT-CC
MSRP	\$800.00
Advance d	
\$750	
Complete Printed Graphic Set	
X	
code	LN-K-TT-CC-G
MSRP	\$500.00
Advance d	
\$369	

Linear Tabletop Kit DD	
lifetime warranty	
Complete Hardware Kit	
code	LN-K-TT-DD
MSRP	\$800.00
Advance d	
\$750	
Complete Printed Graphic Set	
X	
code	LN-K-TT-DD-G
MSRP	\$500.00
Advance d	
\$369	

Linear Tabletop Kit EE	
lifetime warranty	
Complete Hardware Kit	
code	LN-K-TT-EE
MSRP	\$800.00
Advance d	
\$750	
Complete Printed Graphic Set	
X	
code	LN-K-TT-EE-G
MSRP	\$500.00
Advance d	
\$369	

Linear Tabletop Kit FF	
lifetime warranty	
Complete Hardware Kit	
code	LN-K-TT-FF
MSRP	\$800.00
Advance d	
\$750	
Complete Printed Graphic Set	
X	
code	LN-K-TT-FF-G
MSRP	\$500.00
Advance d	
\$369	

Linear Tabletop Kit GG	
lifetime warranty	
Complete Hardware Kit	
code	LN-K-TT-GG
MSRP	\$800.00
Advance d	
\$750	
Complete Printed Graphic Set	
X	
code	LN-K-TT-GG-G
MSRP	\$500.00
Advance d	
\$369	

Linear Tabletop Kit HH	
lifetime warranty	
Complete Hardware Kit	
code	LN-K-TT-HH
MSRP	\$800.00
Advance d	
\$750	
Complete Printed Graphic Set	
X	
code	LN-K-TT-HH-G
MSRP	\$500.00
Advance d	
\$369	

*Each Linear hardware kit includes all of the hardware required to assemble the display, graphic mounting materials, an OCH shipping case(s) & 2 Lumina lights of your choice. Does not include graphics.

X = includes printing on wings from hardware kit & printed center panels



Linear tabletop displays

The next evolution in tabletop presentation. Simple and lightweight, they are cost effect, easy to transport, take just minutes to assemble, yet bring an enhanced and dynamic sophistication to your tabletop presentation.

all kits include:

- advanced aluminum structure
- stylis h 50 watt low voltage lighting
- rugged plastic molded transit & storage case
- step-by-step setup instructions
- fully customizable, high quality digitally printed graphic options available

Linear 10x10 Kits

Linear 10'x10' Kit 01
lifetime warranty



includes 2 lights
1 OCH case & 1 OCS case

Hardware Kit
includes wing & header panels

code	LN-K-3P-01
MSRP	\$1,690.00

Advanced
\$1,625

Complete Printed Graphic Set
*

code	LN-K-3P-01-G
MSRP	\$1,200.00

Advanced
\$915

Linear 10'x10' Kit 02
lifetime warranty



includes 2 lights
1 OCH case & 1 OCS case

Complete Hardware Kit
includes wing & header panels

code	LN-K-3P-02
MSRP	\$1,690.00

Advanced
\$1,625

Complete Printed Graphic Set
*

code	LN-K-3P-02-G
MSRP	\$1,200.00

Advanced
\$915

Linear 10'x10' Kit 03
lifetime warranty



includes 2 lights
1 OCH case & 1 OCS case

Complete Hardware Kit
includes wing & header panels

code	LN-K-3P-03
MSRP	\$1,690.00

Advanced
\$1,625

Complete Printed Graphic Set
*

code	LN-K-3P-03-G
MSRP	\$1,200.00

Advanced
\$915

Linear 10'x10' Kit 04
lifetime warranty

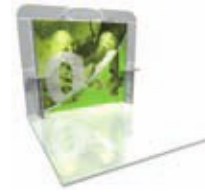

includes 2 lights
1 OCH case & 1 OCS case

Complete Hardware Kit
includes wing & header panels

code	LN-K-3P-04
MSRP	\$1,630.00

Advanced
\$1,569

Complete Printed Graphic Set
*

code	LN-K-3P-04-G
MSRP	\$1,200.00

Advanced
\$915

Linear 10'x10' Kit 05
lifetime warranty



includes 2 lights
1 OCH case & 1 OCS case

Complete Hardware Kit
includes wing & header panels

code	LN-K-3P-05
MSRP	\$1,625.00

Advanced
\$1,569

Complete Printed Graphic Set
*

code	LN-K-3P-05-G
MSRP	\$1,200.00

Advanced
\$915

lifetime warranty



includes 2 lights
1 OCH case & 1 OCS case

Complete Hardware Kit
includes wing & header panels

code	LN-K-3P-06
MSRP	\$1,465.00

Advanced
\$1,419

Complete Printed Graphic Set
*

code	LN-K-3P-06-G
MSRP	\$1,200.00

Advanced
\$915

lifetime warranty



includes 2 lights
1 OCH case & 1 OCS case

Complete Hardware Kit
includes wing & header panels

code	LN-K-3P-07
MSRP	\$1,575.00

Advanced
\$1,498

Complete Printed Graphic Set
*

code	LN-K-3P-07-G
MSRP	\$1,200.00

Advanced
\$915

lifetime warranty



includes 2 lights
1 OCH case & 1 OCS case

Complete Hardware Kit
includes wing & header panels

code	LN-K-3P-08
MSRP	\$1,575.00

Advanced
\$1,519

Complete Printed Graphic Set
*

code	LN-K-3P-08-G
MSRP	\$1,200.00

Advanced
\$915

lifetime warranty



includes 2 lights
1 OCH case & 1 OCS case

Complete Hardware Kit
includes wing & header panels

code	LN-K-3P-09
MSRP	\$1,465.00

Advanced
\$1,419

Complete Printed Graphic Set
*

code	LN-K-3P-09-G
MSRP	\$1,200.00

Advanced
\$915

lifetime warranty



includes 2 lights
1 OCH case & 1 OCS case

Complete Hardware Kit
includes wing & header panels

code	LN-K-3P-10
MSRP	\$1,465.00

Advanced
\$1,419

Complete Printed Graphic Set
*

code	LN-K-3P-10-G
MSRP	\$1,200.00

Advanced
\$915

all Linear kits include your choice of low voltage lighting:

* = includes printing on wings from hardware kit & printed center panels

Lumina 1 Spotlight	Lumina 3 Spotlight	Lumina 7 Spotlight	Lumina 8 Spotlight
LUM-1 1 year warranty	LUM-3 1 year warranty	LUM-7 1 year warranty	LUM-8 1 year warranty
			

shipping & transport cases:



Parts included in each kit are limited to their own specific warranties.

Linear 10'x20' Kit 11

lifetime warranty



includes 4 lights
2 OCH cases & 2 OCS cases

Complete Hardware Kit

includes wing & header panels

code	LN-K-3P-11
MSRP	\$3,270.00

Advanced
\$3,139

Complete Printed Graphic Set

*

code	LN-K-3P-11-G
MSRP	\$2,500.00

Advanced
\$1,875

Linear 10'x20' Kit 12

lifetime warranty



includes 4 lights
2 OCH cases & 2 OCS cases

Complete Hardware Kit

includes wing & header panels

code	LN-K-3P-12
MSRP	\$3,300.00

Advanced
\$3,159

Complete Printed Graphic Set

*

code	LN-K-3P-12-G
MSRP	\$2,500.00

Advanced
\$1,875

Linear 10'x20' Kit 13

lifetime warranty



includes 4 lights
2 OCH cases & 2 OCS cases

Complete Hardware Kit

includes wing & header panels

code	LN-K-3P-13
MSRP	\$3,100.00

Advanced
\$2,989

Complete Printed Graphic Set

*

code	LN-K-3P-13-G
MSRP	\$2,500.00

Advanced
\$1,875

Linear 10'x20' Kit 14

lifetime warranty

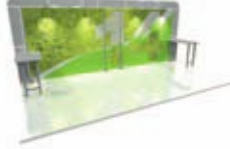

includes 4 lights
2 OCH cases & 2 OCS cases

Complete Hardware Kit

includes wing & header panels

code	LN-K-3P-14
MSRP	\$3,230.00

Advanced
\$3,125

Complete Printed Graphic Set

*

code	LN-K-3P-14-G
MSRP	\$2,500.00

Advanced
\$1,875

Linear 10'x20' Kit 15

lifetime warranty



includes 4 lights
2 OCH cases & 2 OCS cases

Complete Hardware Kit

includes wing & header panels

code	LN-K-3P-15
MSRP	\$3,270.00

Advanced
\$3,139

Complete Printed Graphic Set

*

code	LN-K-3P-15-G
MSRP	\$2,500.00

Advanced
\$1,875

Linear 10'x20' Kit 16

lifetime warranty



includes 4 lights
2 OCH cases & 2 OCS cases

Complete Hardware Kit

includes wing & header panels

code	LN-K-3P-16
MSRP	\$2,900.00

Advanced
\$2,769

Complete Printed Graphic Set

*

code	LN-K-3P-16-G
MSRP	\$2,500.00

Advanced
\$1,875

Linear 10'x20' Kit 17

lifetime warranty



includes 4 lights
2 OCH cases & 2 OCS cases

Complete Hardware Kit

includes wing & header panels

code	LN-K-3P-17
MSRP	\$3,060.00

Advanced
\$2,945

Complete Printed Graphic Set

*

code	LN-K-3P-17-G
MSRP	\$2,500.00

Advanced
\$1,875

Linear 10'x20' Kit 18

lifetime warranty



includes 4 lights
2 OCH cases & 2 OCS cases

Complete Hardware Kit

includes wing & header panels

code	LN-K-3P-18
MSRP	\$3,100.00

Advanced
\$2,925

Complete Printed Graphic Set

*

code	LN-K-3P-18-G
MSRP	\$2,500.00

Advanced
\$1,875

Linear 10'x20' Kit 19

lifetime warranty



includes 4 lights
2 OCH cases & 2 OCS cases

Complete Hardware Kit

includes wing & header panels

code	LN-K-3P-19
MSRP	\$3,270.00

Advanced
\$3,139

Complete Printed Graphic Set

*

code	LN-K-3P-19-G
MSRP	\$2,500.00

Advanced
\$1,875

Linear 10'x20' Kit 20

lifetime warranty



includes 4 lights
2 OCH cases & 2 OCS cases

Complete Hardware Kit

includes wing & header panels

code	LN-K-3P-20
MSRP	\$2,900.00

Advanced
\$2,769

Complete Printed Graphic Set

*

code	LN-K-3P-20-G
MSRP	\$2,500.00

Advanced
\$1,875

shipping & transport case:

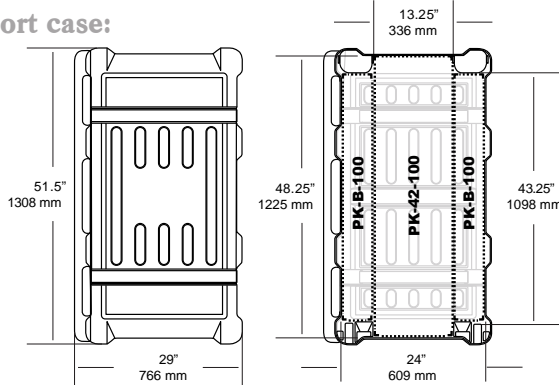



* = includes printing on wings from hardware kit & printed center panels

all kits include

- advanced aluminum structure
- stylish 50 watt low voltage lighting
- tabletops or counters where indicated
- rugged plastic molded transit & storage case(s)
- step-by-step instructions

Parts included in each kit are limited to their own specific warranties.

Linear PRO 10'x10' Kit 21	
lifetime warranty	
	
includes 2 lights 2 OCH cases & 1 OCS case	
Complete Hardware Kit	
includes wing & header panels	
code	LN-K-3P-21
MSRP	\$2,965.00
Complete Printed Graphic Set	
*	
code	LN-K-3P-21-G
MSRP	\$1,200.00
Advanced	
\$889	

Linear PRO 10'x10' Kit 22	
lifetime warranty	
	
includes 2 lights 2 OCH cases & 1 OCS case	
Complete Hardware Kit	
includes wing & header panels	
code	LN-K-3P-22
MSRP	\$3,390.00
Complete Printed Graphic Set	
*	
code	LN-K-3P-22-G
MSRP	\$1,200.00
Advanced	
\$889	

Linear PRO 10'x10' Kit 23	
lifetime warranty	
	
includes 2 lights 2 OCH cases & 1 OCS case	
Complete Hardware Kit	
includes wing & header panels	
code	LN-K-3P-23
MSRP	\$2,965.00
Complete Printed Graphic Set	
*	
code	LN-K-3P-23-G
MSRP	\$1,200.00
Advanced	
\$889	

Linear PRO 10'x10' Kit 24	
lifetime warranty	
	
includes 2 lights 2 OCH cases & 1 OCS case	
Complete Hardware Kit	
includes wing & header panels	
code	LN-K-3P-24
MSRP	\$3,440.00
Complete Printed Graphic Set	
*	
code	LN-K-3P-24-G
MSRP	\$1,200.00
Advanced	
\$889	

Linear PRO 10'x10' Kit 25	
lifetime warranty	
	
includes 2 lights 2 OCH cases & 1 OCS case	
Complete Hardware Kit	
includes wing & header panels	
code	LN-K-3P-25
MSRP	\$3,390.00
Complete Printed Graphic Set	
*	
code	LN-K-3P-25-G
MSRP	\$1,200.00
Advanced	
\$889	

Linear PRO 10'x20' Kit 26	
lifetime warranty	
	
includes 4 lights 4 OCH cases & 2 OCS cases	
Complete Hardware Kit	
includes wing & header panels	
code	LN-K-3P-26
MSRP	\$5,090.00
Complete Printed Graphic Set	
*	
code	LN-K-3P-26-G
MSRP	\$2,350.00
Advanced	
\$1,669	

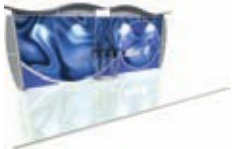
Linear PRO 10'x20' Kit 27	
lifetime warranty	
	
includes 4 lights 4 OCH cases & 2 OCS cases	
Complete Hardware Kit	
includes wing & header panels	
code	LN-K-3P-27
MSRP	\$4,665.00
Complete Printed Graphic Set	
*	
code	LN-K-3P-27-G
MSRP	\$2,350.00
Advanced	
\$1,669	

Linear PRO 10'x20' Kit 28	
lifetime warranty	
	
includes 4 lights 4 OCH cases & 2 OCS cases	
Complete Hardware Kit	
includes wing & header panels	
code	LN-K-3P-28
MSRP	\$4,665.00
Complete Printed Graphic Set	
*	
code	LN-K-3P-28-G
MSRP	\$2,350.00
Advanced	
\$1,669	

Linear PRO 10'x20' Kit 29	
lifetime warranty	
	
includes 4 lights 4 OCH cases & 2 OCS cases	
Complete Hardware Kit	
includes wing & header panels	
code	LN-K-3P-29
MSRP	\$4,665.00
Complete Printed Graphic Set	
*	
code	LN-K-3P-29-G
MSRP	\$2,350.00
Advanced	
\$1,669	

Linear PRO 10'x20' Kit 30	
lifetime warranty	
	
includes 4 lights 4 OCH cases & 2 OCS cases	
Complete Hardware Kit	
includes wing & header panels	
code	LN-K-3P-30
MSRP	\$4,410.00
Complete Printed Graphic Set	
*	
code	LN-K-3P-30-G
MSRP	\$2,350.00
Advanced	
\$1,669	

* = includes printing on wings from hardware kit & printed center panels

Parts included in each kit are limited to their own specific warranties.

Linear BOLD 10'x10' Kit 31
lifetime warranty



2 OCH2 cases

Hardware Only	
includes wing & header panels	
code	LN-K-31
MSRP	\$4,510.00
Advanced	
\$4,125	
Complete Printed Graphic Set Only	
includes printing on wings from hardware kit & printed center panels	
code	LN-K-31-FG
MSRP	\$1,060.00
Advanced	
\$847	

Linear BOLD 10'x20' Kit 32
lifetime warranty



includes 4 spotlights
3 OCH2 cases

Complete Hardware Kit	
includes wing & header panels	
code	LN-K-32
MSRP	\$6,810.00
Advanced	
\$6,239	
Complete Printed Graphic Set	
includes printing on wings from hardware kit & printed center panels	
code	LN-K-32-FG
MSRP	\$2,300.00
Advanced	
\$1,825	

Linear BOLD 10'x10' Kit 33
lifetime warranty



2 OCH2 cases

Complete Hardware Kit	
includes wing & header panels	
code	LN-K-33
MSRP	\$5,070.00
Advanced	
\$4,639	
Complete Printed Graphic Set	
includes printing on wings from hardware kit & printed center panels	
code	LN-K-33-FG
MSRP	\$1,700.00
Advanced	
\$1,350	

Linear BOLD 10'x20' Kit 34
lifetime warranty



includes 8 spotlights 5 OCH2 cases

Complete Hardware Kit	
includes wing & header panels	
code	LN-K-34
MSRP	\$10,205.00
Advanced	
\$9,348	
Complete Printed Graphic Set	
includes printing on wings from hardware kit & printed center panels	
code	LN-K-34-FG
MSRP	\$5,239
Advanced	
\$2,495	

Linear BOLD 10'x10' Kit 35
lifetime warranty



includes 2 spotlights
2 OCH2 cases

Complete Hardware Kit	
includes wing & header panels	
code	LN-K-35
MSRP	\$3,765.00
Advanced	
\$3,445	
Complete Printed Graphic Set	
includes printing on wings from hardware kit & printed center panels	
code	LN-K-35-FG
MSRP	\$1,020.00
Advanced	
\$809	

Linear BOLD 10'x20' Kit 36
lifetime warranty



includes 5 spotlights
3 OCH2 cases

Complete Hardware Kit	
includes wing & header panels	
code	LN-K-36
MSRP	\$5,565.00
Advanced	
\$5,091	
Complete Printed Graphic Set	
includes printing on wings from hardware kit & printed center panels	
code	LN-K-36-FG
MSRP	\$1,890.00
Advanced	
\$1,500	

Linear BOLD 10'x10' Kit 37
lifetime warranty



includes 4 spotlights 3 OCH2 cases

Complete Hardware Kit	
includes wing & header panels	
code	LN-K-37
MSRP	\$6,785.00
Advanced	
\$6,209	
Complete Printed Graphic Set	
includes printing on wings from hardware kit & printed center panels	
code	LN-K-37-FG
MSRP	\$1,790.00
Advanced	
\$1,419	

Linear BOLD 10'x20' Kit 38
lifetime warranty



includes 8 spotlights 6 OCH2 cases

Complete Hardware Kit	
includes wing & header panels	
code	LN-K-38
MSRP	\$13,440.00
Advanced	
\$12,300	
Complete Printed Graphic Set	
includes printing on wings from hardware kit & printed center panels	
code	LN-K-38-FG
MSRP	\$3,660.00
Advanced	
\$2,900	

all Linear kits include your choice of low voltage lighting:

shipping & transport cases:

Lumina 1 Spotlight	Lumina 3 Spotlight	Lumina 7 Spotlight	Lumina 8 Spotlight
LUM-1	LUM-3	LUM-7	LUM-8
1 year warranty	1 year warranty	1 year warranty	1 year warranty
			



Parts included in each kit are limited to their own specific warranties.

Monitor Bracket 01	
 <p>5 year</p> <p>13"-27" LCD max weight= 50</p>	
code	LN-LCD1-B
MSRP	\$144.50
Trade Prices (Hardware)	
Advan	
\$135	

Monitor Bracket 02	
 <p>5 year</p> <p>26"-42" LCD max weight= 80</p>	
code	LN-LCD2-B
MSRP	\$221.00
Trade Prices (Hardware)	
Advan	
\$209	

Monitor Bracket 02	
 <p>1 year</p>	
code	LN112
MSRP	\$60.00
Trade Prices (Hardware)	
Advan	
\$50	

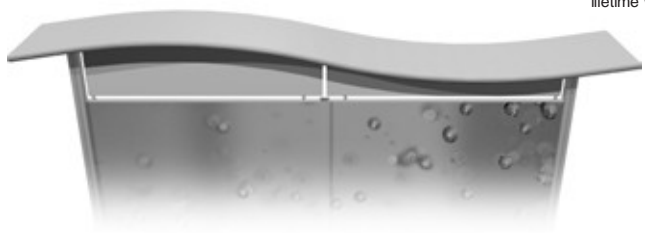
S-Shaped Canopy		
 <p>lifetime warranty</p>	Hardware & Pillowcase Sleeve (silver, black, white) - price includes printing on header panel	
	code	LN-CAN-S
	MSRP	\$1,035.00
	Advan	
	\$959	

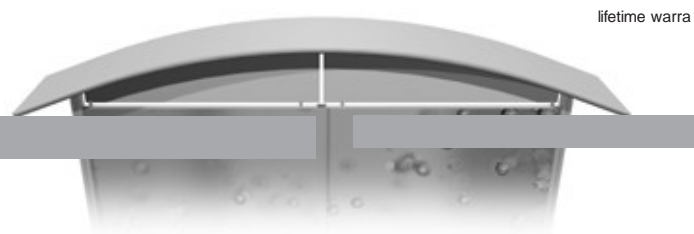
C- Shaped Canopy		
 <p>lifetime warranty</p>	Hardware & Pillowcase Sleeve (silver, black, white) - price includes printing on header panel	
	code	LN-CAN-C
	MSRP	\$1,017.00
	Advan	
	\$949	

all Linear kits include your choice of low voltage lighting:

Lumina 1 Spotlight	Lumina 3 Spotlight	Lumina 7 Spotlight	Lumina 8 Spotlight
LUM-1 1 year warranty	LUM-3 1 year warranty	LUM-7 1 year warranty	LUM-8 1 year warranty
			

shipping & transport cases:



V-Leg Table - Oval

lifetime warranty

1



uses 1/2 of OCH2 shipping case (not included)

Trade Price (Hardware)	
code	LN-A-WS-01
MSRP	\$587.00
Advance d	
\$59	

Tusk-Leg Table - Oval

lifetime warranty

2

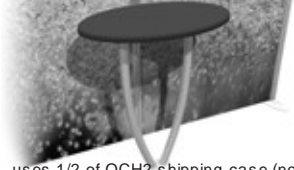

uses 1/2 of OCH2 shipping case (not included)

Trade Price (Hardware)	
code	LN-A-WS-02
MSRP	\$587.00
Advance d	

Straight-Leg Table - Oval

lifetime warranty

3



uses 1/2 of OCH2 shipping case (not included)

Trade Price (Hardware)	
code	LN-A-WS-03
MSRP	\$587.00
Advance d	

V-Leg Table -

lifetime warranty

4

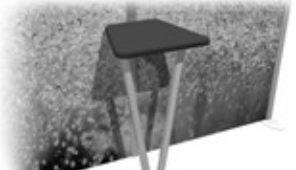

uses 1/2 of OCH2 shipping case (not included)

Trade Price (Hardware)	
code	LN-A-WS-04
MSRP	\$519.00
Advance d	
\$495	

Tusk-Leg Table -

lifetime

5



uses 1/2 of OCH2 shipping case (not included)

Trade Price (Hardware)	
code	LN-A-WS-05
MSRP	\$519.00
Advance d	

Straight-Leg Table -

lifetime

6

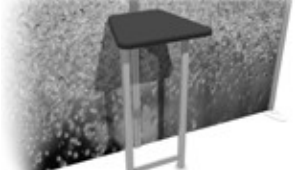

uses 1/2 of OCH2 shipping case (not included)

Trade Price (Hardware)	
code	LN-A-WS-06
MSRP	\$519.00
Advance d	

Counter - Rectangle

lifetime warranty

1



comes with locking door and internal shelf, uses 1/2 of OCH2 shipping case (not included)

Trade Price (Hardware)	
code	LN-CU-01
MSRP	\$825.00
Advance d	
\$785	
Trade Price (Graphics)	
code	LN-CU-G
MSRP	\$323.00
Advance d	
\$300	

Straight-Leg Counter

lifetime warranty

2



comes with locking door and internal shelf, uses full OCH2 shipping case (not included)

Trade Price (Hardware)	
code	LN-CU-02
MSRP	\$1,250.00
Advance d	
\$1,195	
Trade Price (Graphics)	
code	LN-CU-G
MSRP	\$323.00
Advance d	
\$300	

V-Leg Counter

lifetime warranty

3



comes with locking door and internal shelf, uses 1 full OCH2 shipping case (not included)

Trade Price (Hardware)	
code	LN-CU-03
MSRP	\$1,250.00
Advance d	
\$1,195	
Trade Price (Graphics)	
code	LN-CU-G
MSRP	\$323.00
Advance d	
\$300	

Tusk-Leg Counter

lifetime warranty

4



comes with locking door and internal shelf, uses 1 full OCH2 shipping case (not included)

Trade Price (Hardware)	
code	LN-CU-04
MSRP	\$1,250.00
Advance d	
\$1,195	
Trade Price (Graphics)	
code	LN-CU-G
MSRP	\$323.00
Advance d	
\$300	

Counter - Oval

lifetime warranty

5



comes with locking door and internal shelf, uses 1/2 of OCH2 shipping case (not included)

Trade Price (Hardware)	
code	LN-CU-05
MSRP	\$927.00
Advance d	
\$885	
Trade Price (Graphics)	
code	LN-CU-G
MSRP	\$323.00
Advance d	
\$300	

Linear Counter

lifetime



choice of laminate countertop finish stand alone counter with

Trade Price (Hardware + Case)	
code	LN-TBL-SA-RCT
MSRP	\$965.00
Advance d	
\$900	
Trade Price (Graphics)	
code	LN-TBL-SA-RCT-G
MSRP	\$221.00
Advance d	
\$185	

Legs on counters 2-4 can be easily configured in-line or at a right angle depending on your exhibit preference.

Linear Kiosk 01
lifetime warranty



Trade Price (Hardware)	
MSRP	\$2,269.50
advanced	\$2,159
code	LN-K-01
includes monitor mount graphic price includes printed canopy 54.4" w x 99" h x 24" d 1 OCH2 case, maximum monitor weight is 50lbs counter holds maximum weight 100lbs wings can be upgraded with	
Trade Price (Graphic)	
advanced	\$985
code	LN-K-01-G

Linear Kiosk 02
lifetime warranty



Trade Price (Hardware)	
MSRP	\$2,150.50
advanced	\$2,050
code	LN-K-02
includes monitor mount graphic price includes printed canopy 53" w x 96.85" h x 24" d 1 OCH2 case maximum monitor weight is 50lbs wing can be upgraded with frosted plex	
Trade Price (Graphic)	
advanced	\$645
code	LN-K-02-G

Linear Kiosk 03
lifetime warranty



Trade Price (Hardware)	
MSRP	\$2,108.00
advanced	\$2,009
code	LN-K-03
47.33" w x 96.85" h x 24" d 1 OCH2 case counter holds maximum weight	
Trade Price (Graphic)	
advanced	\$909
code	LN-K-03-G

Linear Kiosk 04
lifetime warranty



Trade Price (Hardware)	
MSRP	\$1,997.50
advanced	\$1,900
code	LN-K-04
62.83" w x 97" h x 22" d 1 OCH2 case wings can be upgraded with frosted plex LV1 50 watt spotlight	
Trade Price (Graphic)	
advanced	\$899
code	LN-K-04-G

Linear Monitor Kiosk - Kit 1
lifetime warranty



choice of table top finish, includes case, maximum 40lbs

Trade Price (Hardware)	
MSRP	\$840.00
code	LN-MK-1
Advanced \$775	
Trade Price (Graphics)	
Advanced N/A	

Linear Monitor Kiosk - Kit 2
lifetime warranty



choice of table top finish, includes case, maximum 40lbs

Trade Price (Hardware)	
MSRP	\$1,190.00
code	LN-MK-2
Advanced \$1,095	
Trade Price (Graphics)	
Advanced N/A	

Linear Monitor Kiosk - Kit 3
lifetime warranty



choice of table top finish, includes case, maximum 40lbs

Trade Price (Hardware)	
MSRP	\$1,760.00
code	LN-MK-3
Advanced \$1,619	
Trade Price (Graphics) set of 4 panels	
Advanced \$269	

Linear Monitor Kiosk - Kit 4
lifetime warranty



choice of table top finish, includes case, maximum 40lbs

Trade Price (Hardware)	
MSRP	\$1050.00
code	LN-MK-4
Advanced \$975	
Trade Price (Graphics)	
Advanced	

Linear Monitor Kiosk - Kit 5
lifetime



choice of table top finish, includes case, maximum 40lbs

Trade Price (Hardware)	
MSRP	\$1,830.00
code	LN-MK-5
Advanced \$1,669	
Trade Price (Graphics) set of 8 panels	
Advanced	

Kiosk Graphic Mounting Kit
lifetime



spare pieces to mount wings to kiosks

MSRP	\$52.00
code	LN-MK-G-HDW-K
Trade Price (Hardware)	
Advanced \$45	