



ENTASI 

The Frame & Connectors

Entasi displays are designed to be assembled quickly and easily; that is why they come with the exclusive Quick Lock (QL) connector.* QL connectors require no tools so set-up is always fast and simple. The Entasi frames are constructed using 1.25" anodized 6063-T6 aluminum tubing. For convenience and quick assembly, the tubing is shock corded together so there is no need to sort and match up parts. Additionally, we rivet half the connector to the tubing to assure proper positioning and minimize the amount of loose parts. Entasi frames are extremely durable and lightweight. Every frame comes with simple but detailed instructions and can be set up in minutes.

* Some accessories, 20' Frames and Double Sided Frames require a hex wrench.



Graphics

The main graphic is produced on a wrinkle resistant, flame retardant fabric via an exclusive Photo Fabric® dye sublimation process. By using a "pillow case" construction and our exclusive Clean Fit Backer, we eliminate shadowing and ensure a smooth and snug fit. Podium graphics are also produced using the Photo Fabric® process. Graphics used on the stand-offs are produced, using the highest quality digital photographic equipment, on a clear or flex substrate. Most frames are also available in a design to accommodate double sided graphics.

Flex-Fit Liner

Occasionally, certain graphics and lighting require a liner for added opacity. Our unique Flex-Fit liner provides added opacity without creating puckering and wrinkles associated with lower quality fabric displays.

Clean Fit Backer

Standard finishing includes our exclusive Clean Fit Backer, which produces the cleanest and smoothest graphic cover available. Clean Fit Backers are available in a variety of stock colors at no additional charge.



White



Black



Red
PMS 200U*



Cream
PMS 7499U*



Light Grey
PMS 400U*



Burgundy
PMS 228U*



Maize
PMS 7409U*



Royal Blue
PMS 2945U*



Deep Blue
PMS 293U*



Steel Blue
PMS 647U*

* Non stock colors available (Additional charge). PMS colors are approximate, actual color may vary.

Standard Powder Coating

Only Entasi provides you the option of customizing your display with over 20 different colors. Adding color to your stand offs and accessories allows for more creative options and helps maximize impact.

* Non stock colors are available. See standard powder coating color options (Item #3650)



Packaging

Depending on the accessories, an entire 10' Entasi will ship complete in one 15"w x 12.5"d x 52"l (ID) or 25.5"w x 10"d x 53" l (ID) durable plastic case. 20' units are compact enough to ship in just one of the larger cases.* Each case can be shipped via FedEx or UPS and the smaller case can be checked as luggage with most airlines. Both cases include wheels for easy transport. For protection, all parts for the external frame are sorted into individualized pouches and packaged in one convenient durable bag.



* Accessory dependant

Configuration Example One

8' x 10' Flat Frame
With Arm Table



Qty.	Item	Description	Lbs.
1	3501	8' x 10' Flat Frame	19.00
1	1450	Graphic For Flat Frame	6.75
1	3564	Interchangeable Arm Table - FHC	2.25
1	3680	40" Curved Podium	15.00
1	1581	Graphic for Curved Podium	1.00
1	3616	Small Travel Case	22.25
Total Lbs.			66.25

Configuration Example Two

8' x 10' Horizontal Curved
With Stand Off And Arm Table



Qty.	Item	Description	Lbs.
1	3502	8' x 10' Horizontal Curved Frame	19.00
1	1457	Graphic For Horizontal Curved Frame	7.00
1	3532	36" x 96" Curved Stand Off - HC	10.75
1	1712	Full Graphic For Stand Off	3.50
1	3564	Interchangeable Arm Table - FHC	2.25
1	3572	37.5" Studio Table	18.00
1	3616	Small Travel Case	22.25
Total Lbs.			82.75

Configuration Example Three

8' x 10' Vertical Curved
With Rear Projection Stand Off*



Qty.	Item	Description	Lbs.
1	3503	8' x 10' Vertical Curved Frame	20.00
1	1579	8' x 10' Rear Projection Graphic	6.00
1	1578	Extended Rear Projection Stand Off	11.75
1	3677	Large Rear Projection Screen	5.00
1	3679	Projector Stand	9.50
1	3615	Large Travel Case	34.00
Total Lbs.			86.25

*Projector not included

Configuration Example Four

8' x 10' Web



Qty.	Item	Description	Lbs.
1	3670	8' x 10' Web Frame	30.00
1	1572	Graphic For Web Frame	6.00
1	3681	Arch Podium	15.00
1	1583	Graphic For Arch Podium	1.00
1	3615	Large Travel Case	34.00
Total Lbs.			86.00

Configuration Example Five

8' x 10' Vertical Curved
With 2 Stand Off Shelf Packages



Qty.	Item	Description	Lbs.
1	3503	8' x 10' Vertical Curved Frame	20.00
1	1451	Graphic For Vertical Curved Frame	7.00
2	3534	18" x 96" Curved Stand Off - FVC	19.50
2	1718	Top Graphic For Stand Off	0.50
2	1727	Lower Graphic For Stand Off	1.00
2	3558	18" Curved Stand Off Shelf	7.00
1	3615	Large Travel Case	34.00
Total Lbs.			89.00

Configuration Example Six

8' x 20' Vertical Curved
With 2 Stand Off Shelf
Packages And Arm Tables



Qty.	Item	Description	Lbs.
1	3506	8' x 20' Vertical Curved Frame	40.00
1	1454	Graphic For 8' x 20' Vertical Curved Frame	14.00
2	3530	36" x 96" Straight Stand Off - FVC	21.00
2	1715	Top Graphic For Stand Off	1.00
2	1719	Lower Graphic For Stand Off	2.00
2	3555	36" Straight Stand Off Shelf	11.00
2	3565	Interchangeable Arm Table - VC	7.25
2	3615	Large Travel Case	68.00
Total Lbs.			164.25

Configuration Example Seven

8' x 10' Horizontal Curved
With Straight Stand Off Shelf
Package And Header



Qty.	Item	Description	Lbs.
1	3502	8' x 10' Horizontal Curved Frame	19.00
1	1457	Graphic For Horizontal Curved Frame	7.00
1	3530	36" x 96" Straight Stand Off - FVC	10.50
1	3555	36" Straight Stand Off Shelf Package	5.50
1	1719	Bottom Graphic For Stand Off	1.00
1	3640	Header Bracket	4.00
1	1723	Large Oval Graphic For Header Bracket	2.00
1	3616	Small Travel Case	22.25
Total Lbs.			71.25

Configuration Example Eight

8' x 10' Horizontal Curved
Sloping Right



Qty.	Item	Description	Lbs.
1	3504	8' x 10' Horizontal Curved Sloping Right Frame	20.00
1	1452	Graphic For Horizontal Curved Sloping Right Frame	6.00
1	3616	Small Travel Case	22.25
Total Lbs.			48.25

Configuration Example Nine

8' x 10' Flat Frame
With Curved Stand Off
And Grid Wall



Qty.	Item	Description	Lbs.
1	3501	8' x 10' Flat Frame	19.00
1	1450	Graphic For Flat Frame	6.75
1	3531	36" x 96" Curved Stand Off - FVC	10.75
1	1716	Top Graphic For Stand Off	0.50
1	1720	Bottom Graphic For Stand Off	1.00
1	3650	Powder Coating Stand Off And Grid Wall Fixture	
1	3628	Grid Wall Fixture - 36"	5.00
1	3623	Acrylic Shelf 12" x 16"	1.00
1	3571	40" High Oval Podium	18.00
1	1458	Graphic for Oval Podium	1.00
1	3581	Long Curved Stabilizing Feet	4.00
1	3615	Large Travel Case	34.00
Total Lbs.			101.00

Configuration Example Ten

4' x 6' Vertical
Curved Table Top



Qty.	Item	Description	Lbs.
1	3547	4' x 6' Vertical Curved Frame	8.00
1	1461	Graphic For 4' x 6' Vertical Curved Frame	2.50
Total Lbs.			10.50

Configuration Example Eleven

8' x 10' Vertical Curved
With Stand Off And
Monitor Attachment*



Qty.	Item	Description	Lbs.
1	3503	8' x 10' Vertical Curved Frame	20.00
1	1451	Graphic For Vertical Curved Frame	7.00
1	3531	36" x 96" Curved Stand Off - FVC	10.75
1	1720	Bottom Graphic For Stand Off	1.00
1	3557	36" Stand Off Shelf Package	5.50
1	3605	Flat Panel Monitor Stand Off Attachment - 18"	2.00
1	3581	Long Curved Stabilizing Feet	4.00
1	3616	Small Travel Case	22.25
Total Lbs.			72.50

*Monitor not included

Configuration Example Twelve

8' x 10' Wave - Crest Right
With Horizontal Curve Stand Off



Qty.	Item	Description	Lbs.
1	3671	8' x 10' Wave - Crest Right Frame	35.00
1	1573	Graphic For 8' x 10' Wave - Crest Right Frame	6.00
1	3676	Horizontal Curve Stand Off	11.00
1	1715	Top Graphic For Stand Off	0.50
1	1719	Bottom Graphic For Stand Off	1.00
1	3682	Horizontal Curve Stand Off Shelf	5.00
1	3616	Small Travel Case	22.25
Total Lbs.			80.75

Item #3514

8' x 8'
Flat Frame

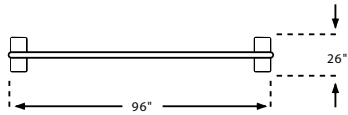

Frame Dimensions: 96" w x 96" h
Frame Weight: 16 Lbs.
Construction: Shock Corded 1.25" Anodized Aluminum Frame With Quick Lock Connectors.

Item #1467

Graphic For 8' x 8'
Flat Frame

*Optional Flex Fit Liner is available

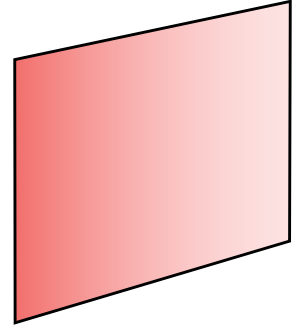

Graphic Dimensions: Refer To Graphic Specifications Sheet
Graphic Weight: 5.75 Lbs.
Construction: Zippered Pillow Cased FR Photo Fabric® Graphic with Clean Fit Backer.

Item #3515

8' x 8'
Horizontal Curved Frame

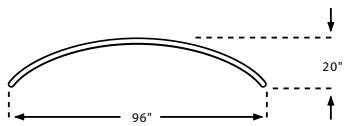

Frame Dimensions: 96" w x 96" h
Frame Weight: 17 Lbs.
Construction: Shock Corded 1.25" Anodized Aluminum frame With Quick Lock Connectors.

Item #1468

Graphic For 8' x 8'
Horizontal Curved Frame

*Optional Flex Fit Liner is available

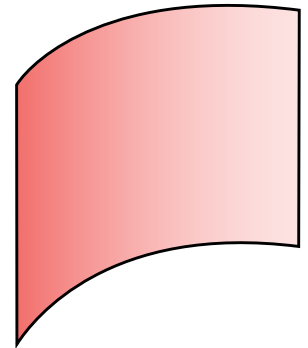

Graphic Dimensions: Refer To Graphic Specifications Sheet
Graphic Weight: 6 Lbs.
Construction: Zippered Pillow Cased FR Photo Fabric® Graphic with Clean Fit Backer.

Item #3516

8' x 8'
Vertical Curved Frame

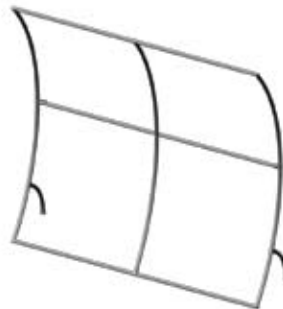
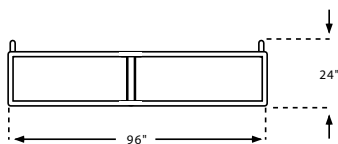

Frame Dimensions: 96" w x 96" h
Frame Weight: 17 Lbs.
Construction: Shock Corded 1.25" Anodized Aluminum frame With Quick Lock Connectors.

Item #1469

Graphic For 8' x 8'
Vertical Curved Frame

*Optional Flex Fit Liner is available

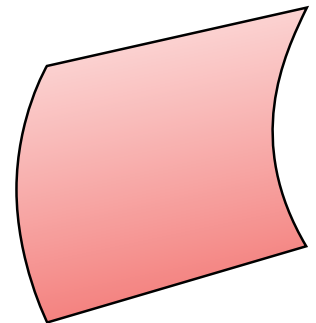

Graphic Dimensions: Refer To Graphic Specifications Sheet
Graphic Weight: 6 Lbs.
Construction: Zippered Pillow Cased FR Photo Fabric® Graphic with Clean Fit Backer.

Item #3501

8' x 10'
Flat Frame

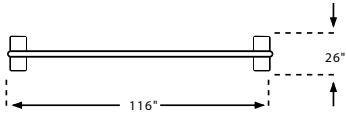

Frame Dimensions: 116"w x 96"h
Frame Weight: 19 Lbs.
Construction: Shock Corded 1.25" Anodized Aluminum Frame With Quick Lock Connectors.

Item #1450

Graphic For 8' x 10'
Flat Frame

*Optional Flex Fit Liner is available

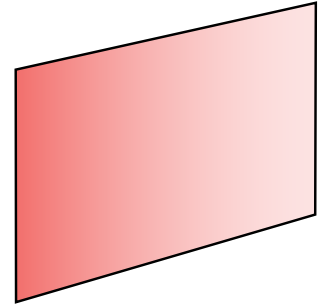

Graphic Dimensions: Refer To Graphic Specifications Sheet
Graphic Weight: 6.75 Lbs.
Construction: Zippered Pillow Cased FR Photo Fabric® Graphic with Clean Fit Backer.

Item #3670

8' x 10'
Web Frame



Frame Dimensions: 116"w x 96"h
Frame Weight: 30 Lbs.
Construction: Shock Corded 1.25" Anodized Aluminum Frame With Quick Lock Connectors.

Item #1572

Graphic For 8' x 10'
Web Frame

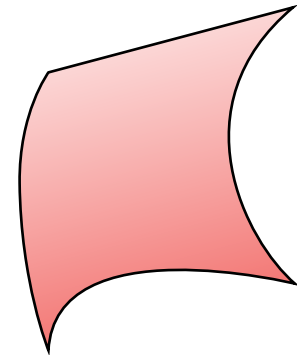

Graphic Dimensions: Refer To Graphic Specifications Sheet
Graphic Weight: 6 Lbs.
Construction: Zippered Pillow Cased FR Photo Fabric® Graphic with Clean Fit Backer.

Item #3502

8' x 10'
Horizontal Curved Frame

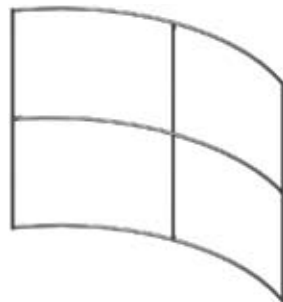
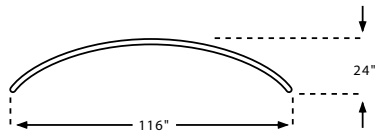

Frame Dimensions: 116"w x 96"h
Frame Weight: 19 Lbs.
Construction: Shock Corded 1.25" Anodized Aluminum Frame With Quick Lock Connectors.

Item #1457

Graphic For 8' x 10'
Horizontal Curved Frame

*Optional Flex Fit Liner is available

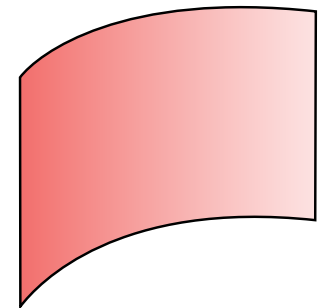

Graphic Dimensions: Refer To Graphic Specifications Sheet
Graphic Weight: 7 Lbs.
Construction: Zippered Pillow Cased FR Photo Fabric® Graphic with Clean Fit Backer.

Item #3503

8' x 10'
Vertical Curved Frame

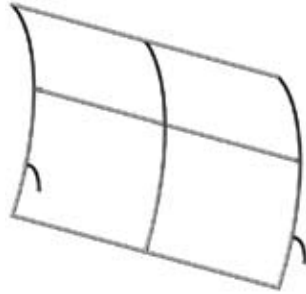
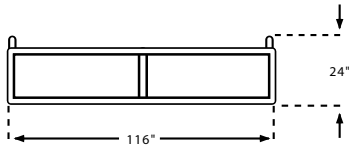

Frame Dimensions: 116" w x 96" h

Frame Weight: 20 Lbs.

Construction: Shock Corded 1.25" Anodized Aluminum Frame With Quick Lock Connectors.

Item #1451

Graphic For 8' x 10'
Vertical Curved Frame

*Optional Flex Fit Liner is available

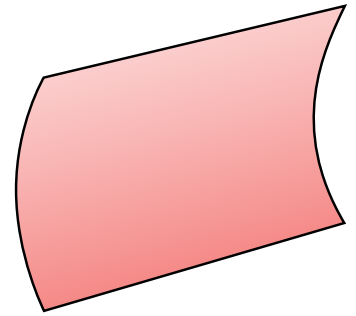

Graphic Dimensions: Refer To Graphic Specifications Sheet

Graphic Weight: 7 Lbs.

Construction: Zippered Pillow Cased FR Photo Fabric® Graphic with Clean Fit Backer.

Item #3504

8' x 10'
Horizontal Curved
Sloping Right Frame

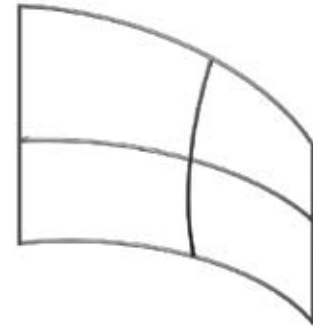
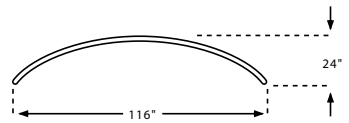

Frame Dimensions: 116" w x 96" h

Frame Weight: 20 Lbs.

Construction: Shock Corded 1.25" Anodized Aluminum Frame With Quick Lock Connectors. Frame Slopes From 8' On The Left To 6' On The Right.

Item #1452

Graphic For 8' x 10'
Horizontal Curved
Sloping Right Frame

*Optional Flex Fit Liner is available

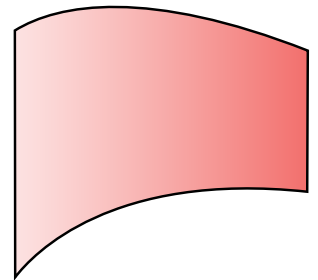

Graphic Dimensions: Refer To Graphic Specifications Sheet

Graphic Weight: 6 Lbs.

Construction: Zippered Pillow Cased FR Photo Fabric® Graphic with Clean Fit Backer.

Item #3505

8' x 10'
Horizontal Curved
Sloping Left Frame

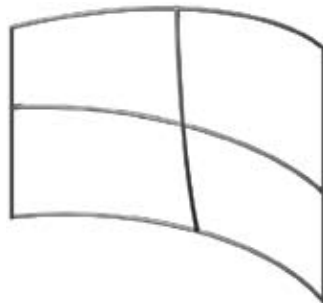
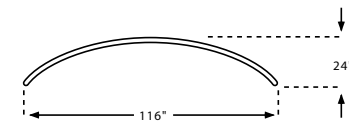

Frame Dimensions: 116" w x 96" h

Frame Weight: 20 Lbs.

Construction: Shock Corded 1.25" Anodized Aluminum Frame With Quick Lock Connectors. Frame Slopes From 6' On The Left To 8' On The Right.

Item #1453

Graphic For 8' x 10'
Horizontal Curved
Sloping Left Frame

*Optional Flex Fit Liner is available

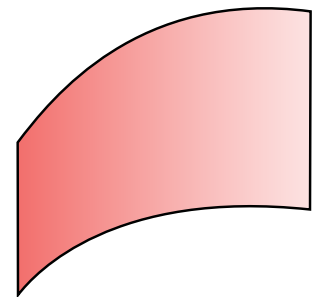

Graphic Dimensions: Refer To Graphic Specifications Sheet

Graphic Weight: 6 Lbs.

Construction: Zippered Pillow Cased FR Photo Fabric® Graphic with Clean Fit Backer.

Item #3671

8' x 10'
Wave Frame - Crest Right

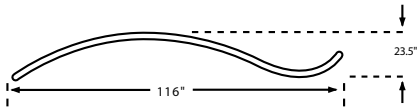
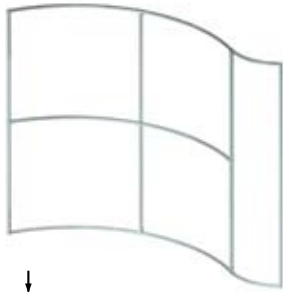

Frame Dimensions: 116"w x 96"h
Frame Weight: 35 Lbs.
Construction: Shock Corded 1.25" Anodized Aluminum Frame With Hex Wrench Connectors.

Item #1573

Graphic For 8' x 10'
Wave Frame - Crest Right

*Optional Flex Fit Liner is available

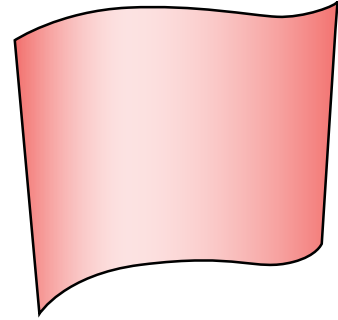

Graphic Dimensions: Refer To Graphic Specifications Sheet
Graphic Weight: 6 Lbs.
Construction: Zippered Pillow Cased FR Photo Fabric® Graphic with Clean Fit Backer.

Item #3672

8' x 10'
Wave Frame - Crest Left

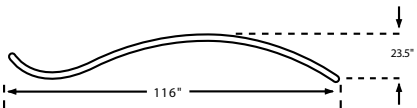
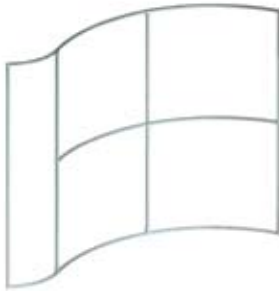

Frame Dimensions: 116"w x 96"h
Frame Weight: 35 Lbs.
Construction: Shock Corded 1.25" Anodized Aluminum Frame With Hex Wrench Connectors.

Item #1574

Graphic For 8' x 10'
Wave Frame - Crest Left

*Optional Flex Fit Liner is available

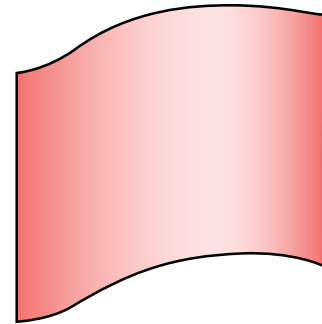

Graphic Dimensions: Refer To Graphic Specifications Sheet
Graphic Weight: 6 Lbs.
Construction: Zippered Pillow Cased FR Photo Fabric® Graphic with Clean Fit Backer.

Item #3507

8' x 20'
Flat Frame

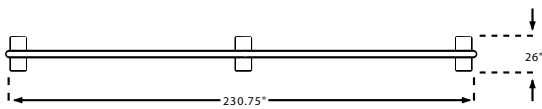
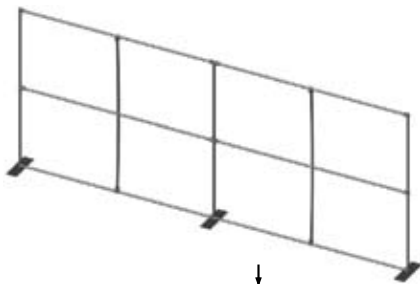

Frame Dimensions: 230.75"w x 96"h
Frame Weight: 40 Lbs.
Construction: Shock Corded 1.25" Anodized Aluminum Frame With Hex Wrench Connectors.

Item #1455

Graphic For 8' x 20'
Flat Frame

*Optional Flex Fit Liner is available

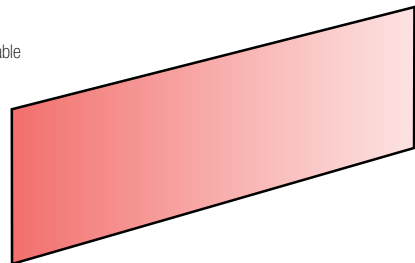

Graphic Dimensions: Refer To Graphic Specifications Sheet
Graphic Weight: 13 Lbs.
Construction: Zippered Pillow Cased FR Photo Fabric® Graphic with Clean Fit Backer.

Item #3508

8' x 20'
Horizontal Curved Frame

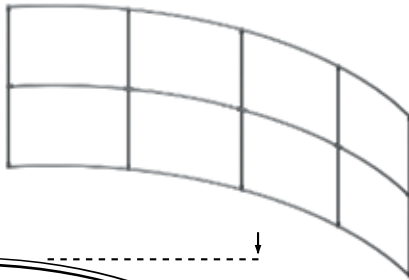

Frame Dimensions: 232"w x 96"h

Frame Weight: 40 Lbs.

Construction: Shock Corded 1.25" Anodized Aluminum Frame With Hex Wrench Connectors.

Item #1456

Graphic For 8' x 20'
Horizontal Curved Frame

*Optional Flex Fit Liner is available

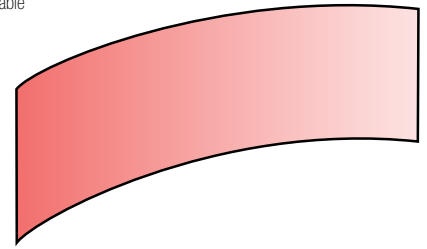

Graphic Dimensions: Refer To Graphic Specifications Sheet

Graphic Weight: 14 Lbs.

Construction: Zippered Pillow Cased FR Photo Fabric® Graphic with Clean Fit Backer.

Item #3506

8' x 20'
Vertical Curved Frame

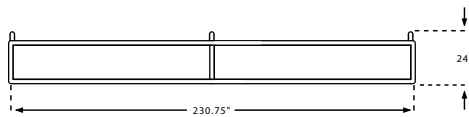
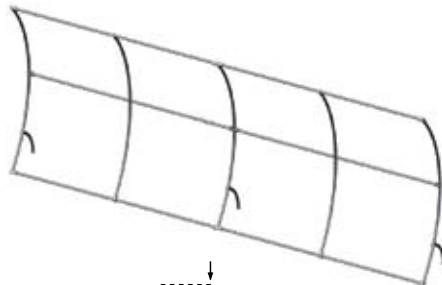

Frame Dimensions: 230.75"w x 96"h

Frame Weight: 40 Lbs.

Construction: Shock Corded 1.25" Anodized Aluminum Frame With Hex Wrench Connectors.

Item #1454

Graphic For 8' x 20'
Vertical Curved Frame

*Optional Flex Fit Liner is available

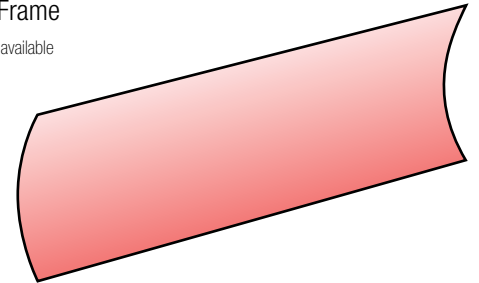

Graphic Dimensions: Refer To Graphic Specifications Sheet

Graphic Weight: 14 Lbs.

Construction: Zippered Pillow Cased FR Photo Fabric® Graphic with Clean Fit Backer.

Item #3517

8' x 20' Convertible Vertical Curved Frame

* Includes 2 Conversion Bars And The Extra Foot Needed To Make 2 Separate 10' Units.

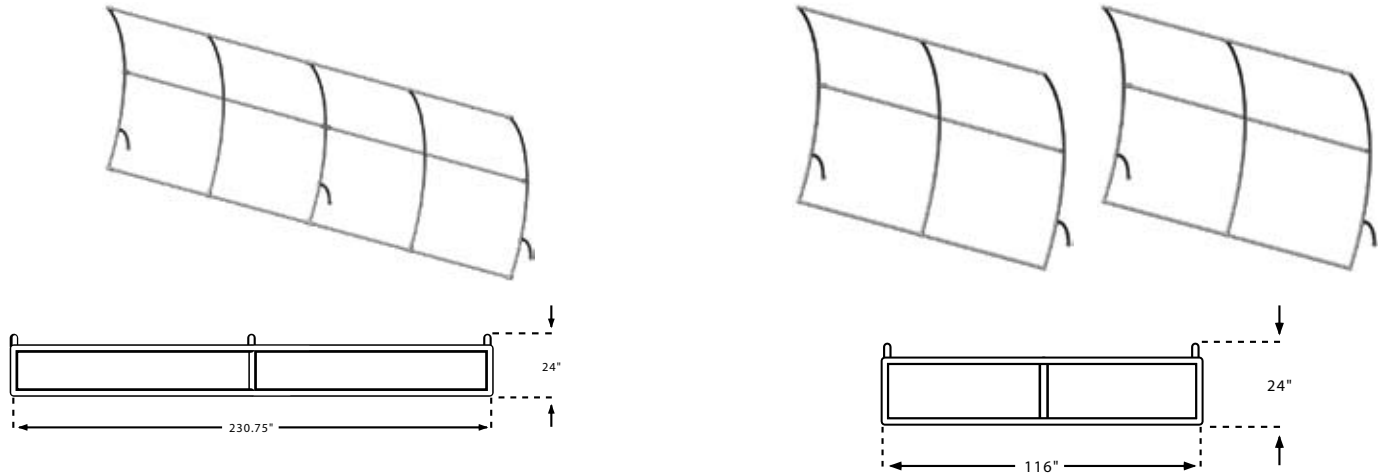

Frame Dimensions: 230.75" w x 96" h or (2) 116" w x 96" h

Frame Weight: 43 Lbs.

Construction: Shock Corded 1.25" Anodized Aluminum Frame With Hex Wrench Connectors.

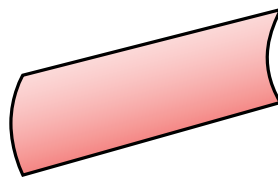

For graphics, reference Item #1454

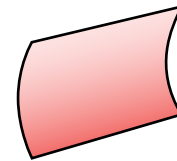

For graphics, reference Item #1451

Item #3518

8' x 20' Convertible Flat Frame

* Includes 2 Conversion Bars And The Extra Foot Needed To Make 2 Separate 10' Units.

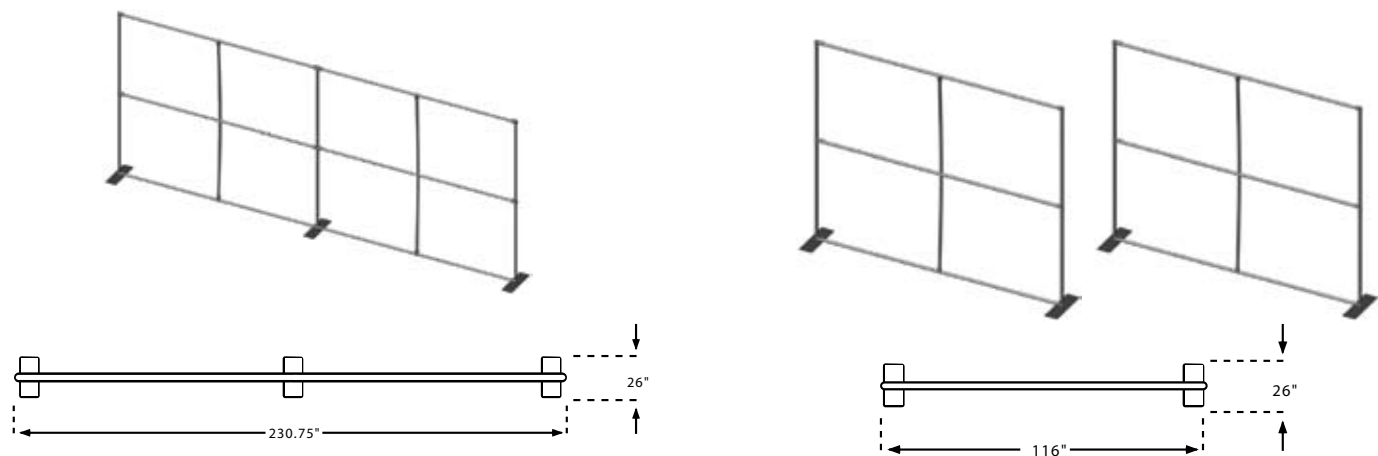

Frame Dimensions: 230.75" w x 96" h or (2) 116" w x 96" h

Frame Weight: 43 Lbs.

Construction: Shock Corded 1.25" Anodized Aluminum Frame With Hex Wrench Connectors.

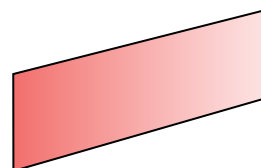

For graphics, reference Item #1455

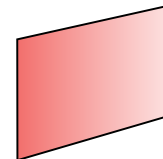

For graphics, reference Item #1450

Item #3509

Double Sided 8' x 10'
Flat Frame

2 – Sided Graphic Frame

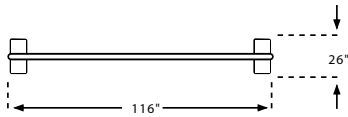

Frame Dimensions: 116"w x 96"h

Frame Weight: 20 Lbs.

Construction: Shock Corded 1.25" Anodized Aluminum Frame With Hex Wrench Connectors.

Item #1462

Double Sided Graphic
For 8' x 10'
Flat Frame

*Optional Flex Fit Liner is available

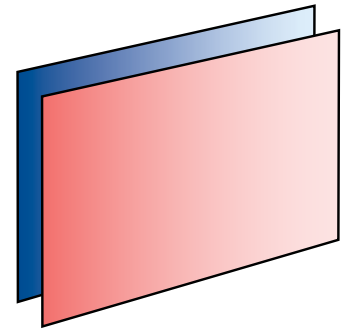

Graphic Dimensions: Refer To Graphic Specifications Sheet

Graphic Weight: 6.75 Lbs.

Construction: Zippered Pillow Cased FR Photo Fabric® Graphic with Clean Fit Backer.

Item #3673

Double Sided 8' x 10'
Web Frame

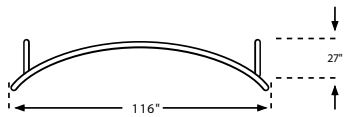

Frame Dimensions: 116"w x 96"h

Frame Weight: 30 Lbs.

Construction: Shock Corded 1.25" Anodized Aluminum Frame With Hex Wrench Connectors.

Item #1575

Double Sided Graphic
For 8' x 10'
Web Frame

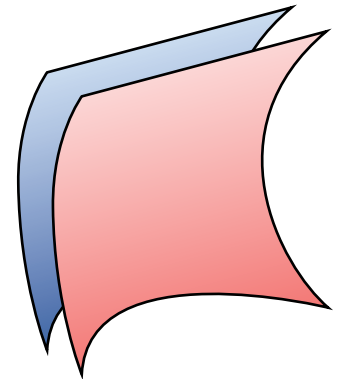

Graphic Dimensions: Refer To Graphic Specifications Sheet

Graphic Weight: 6 Lbs.

Construction: Zippered Pillow Cased FR Photo Fabric® Graphic with Clean Fit Backer.

Item #3510

Double Sided 8' x 10'
Horizontal Curved Frame

2 – Sided Graphic Frame

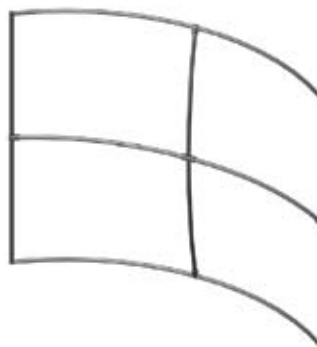
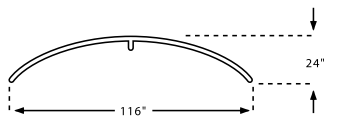

Frame Dimensions: 116"w x 96"h

Frame Weight: 19 Lbs.

Construction: Shock Corded 1.25" Anodized Aluminum Frame With Hex Wrench Connectors.

Item #1463

Double Sided Graphic
For 8' x 10'
Horizontal Curved Frame

*Optional Flex Fit Liner is available

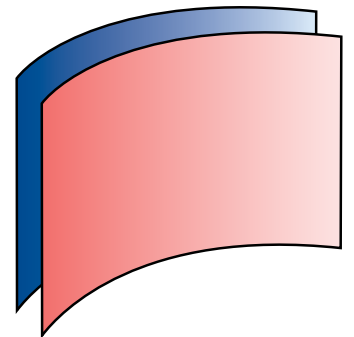

Graphic Dimensions: Refer To Graphic Specifications Sheet

Graphic Weight: 7 Lbs.

Construction: Zippered Pillow Cased FR Photo Fabric® Graphic with Clean Fit Backer.

Item #3511

Double Sided 8' x 10' Vertical Curved Frame

2 - Sided Graphic Frame

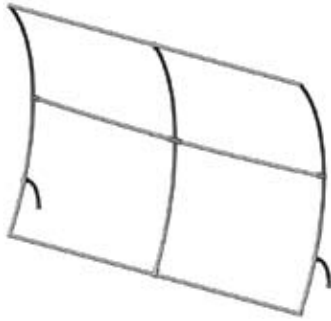
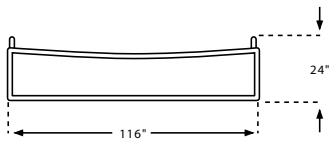

Frame Dimensions: 116" w x 96" h

Frame Weight: 20 Lbs.

Construction: Shock Corded 1.25" Anodized Aluminum Frame With Hex Wrench Connectors.

Item #1464

Double Sided Graphic For 8' x 10' Vertical Curved Frame

*Optional Flex Fit Liner is available

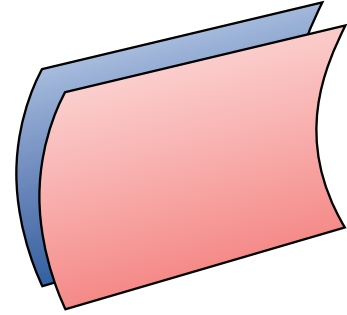

Graphic Dimensions: Refer To Graphic Specifications Sheet

Graphic Weight: 7 Lbs.

Construction: Zippered Pillow Cased FR Photo Fabric® Graphic with Clean Fit Backer.

Item #3512

Double Sided 8' x 10' Horizontal Curved Sloping Right Frame

2 - Sided Graphic Frame

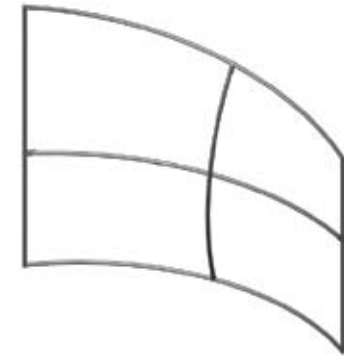
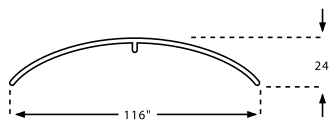

Frame Dimensions: 116" w x 96" h

Frame Weight: 20 Lbs.

Construction: Shock Corded 1.25" Anodized Aluminum Frame With Hex Wrench Connectors. Frame Slopes From 8' On The Left To 6' On The Right

Item #1465

Double Sided Graphic For 8' x 10' Horizontal Curved Sloping Right Frame

*Optional Flex Fit Liner is available

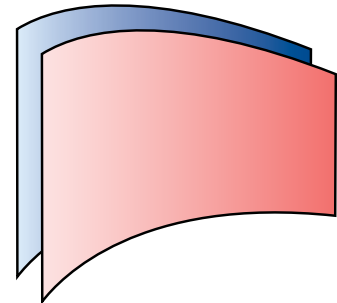

Graphic Dimensions: Refer To Graphic Specifications Sheet

Graphic Weight: 6 Lbs.

Construction: Zippered Pillow Cased FR Photo Fabric® Graphic with Clean Fit Backer.

Item #3513

Double Sided 8' x 10' Horizontal Curved Sloping Left Frame

2 - Sided Graphic Frame

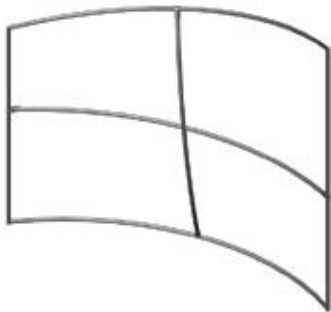
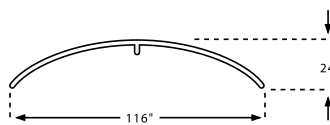

Frame Dimensions: 116" w x 96" h

Frame Weight: 20 Lbs.

Construction: Shock Corded 1.25" Anodized Aluminum Frame With Hex Wrench Connectors. Frame Slopes From 6' On The Left To 8' On The Right

Item #1470

Double Sided Graphic For 8' x 10' Horizontal Curved Sloping Left Frame

*Optional Flex Fit Liner is available

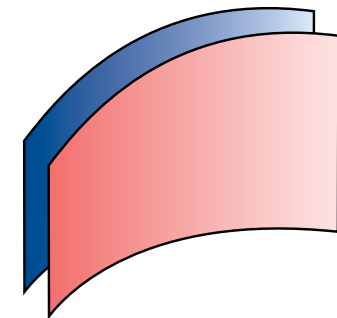

Graphic Dimensions: Refer To Graphic Specifications Sheet

Graphic Weight: 6 Lbs.

Construction: Zippered Pillow Cased FR Photo Fabric® Graphic With Clean Fit Backer.

Item #3674

Double Sided 8' x 10'
Wave Frame – Crest Right

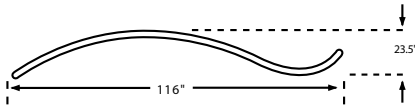
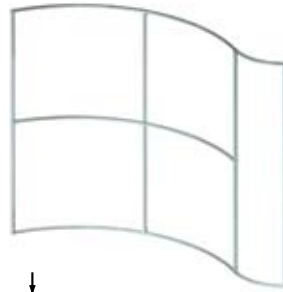

Frame Dimensions: 116"w x 96"h

Frame Weight: 35 Lbs.

Construction: Shock Corded 1.25" Anodized Aluminum Frame With Hex Wrench Connectors.

Item #1576

Double Sided Graphic
For 8' x 10'
Wave Frame – Crest Right

*Optional Flex Fit Liner is available

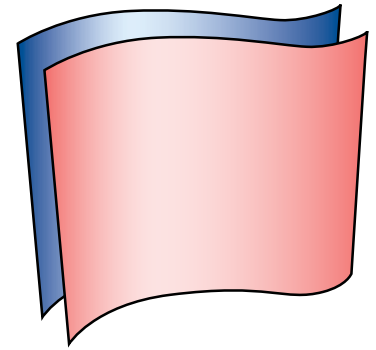

Graphic Dimensions: Refer To Graphic Specifications Sheet

Graphic Weight: 6 Lbs.

Construction: Zippered Pillow Cased FR Photo Fabric® Graphic with Clean Fit Backer.

Item #3675

Double Sided 8' x 10'
Wave Frame – Crest Left

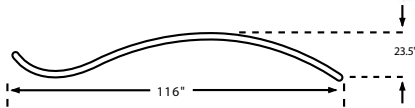
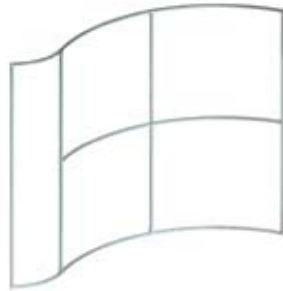

Frame Dimensions: 116"w x 96"h

Frame Weight: 35 Lbs.

Construction: Shock Corded 1.25" Anodized Aluminum Frame With Hex Wrench Connectors.

Item #1577

Double Sided Graphic
For 8' x 10'
Wave Frame – Crest Left

*Optional Flex Fit Liner is available

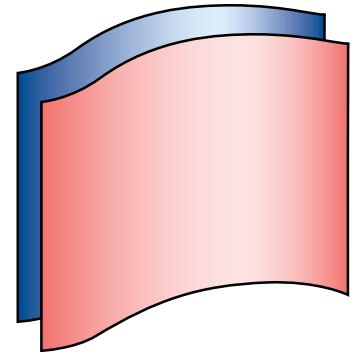

Graphic Dimensions: Refer To Graphic Specifications Sheet

Graphic Weight: 6 Lbs.

Construction: Zippered Pillow Cased FR Photo Fabric® Graphic with Clean Fit Backer.

Item #3545

4' x 6'
Flat Table Top Frame

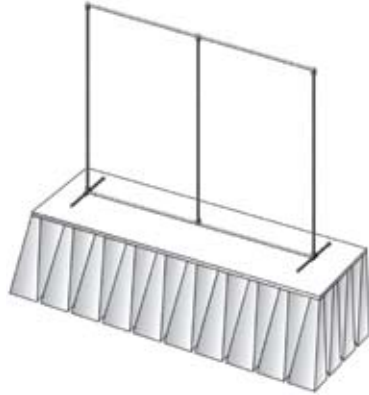

Frame Dimensions: 68" w x 44" h
Graphic Weight: 8 Lbs.
Construction: Shock Corded 1.25" Anodized Aluminum Frame
With Quick Lock Connectors.

Item #1459

Graphic For 4' x 6'
Flat Table Top Frame

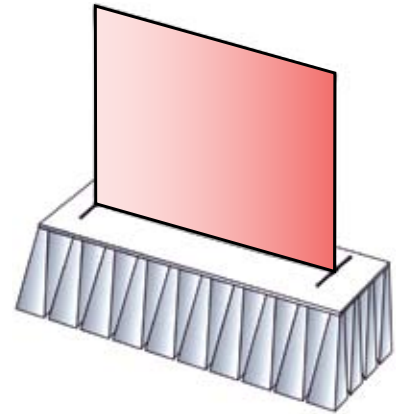

Graphic Dimensions: Refer to Graphic Specifications sheet
Graphic Weight: 2.25 lbs.
Construction: Zippered Pillow Cased FR Photo Fabric® Graphic with Clean Fit Backer.

Item #3546

4' x 6'
Horizontal Curved
Table Top Frame

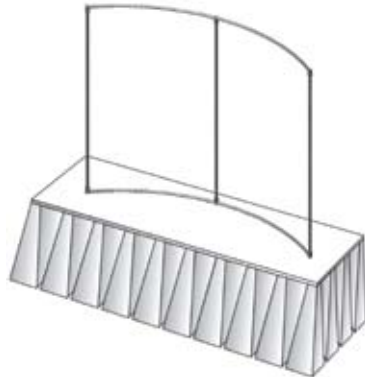

Frame Dimensions: 68" w x 44" h
Graphic Weight: 8 Lbs.
Construction: Shock Corded 1.25" Anodized Aluminum Frame
With Quick Lock Connectors.

Item #1460

Graphic For 4' x 6'
Horizontal Curved
Table Top Frame

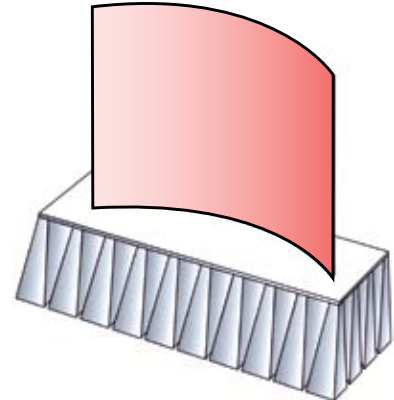

Graphic Dimensions: Refer to Graphic Specifications sheet
Graphic Weight: 2.5 lbs.
Construction: Zippered Pillow Cased FR Photo Fabric® Graphic with Clean Fit Backer.

Item #3547

4' x 6'
Vertical Curved
Table Top Frame

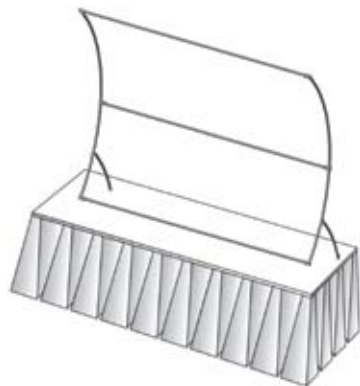

Frame Dimensions: 68" w x 44" h
Graphic Weight: 8 Lbs.
Construction: Shock Corded 1.25" Anodized Aluminum Frame
With Quick Lock Connectors.

Item #1461

Graphic For 4' x 6'
Vertical Curved
Table Top Frame

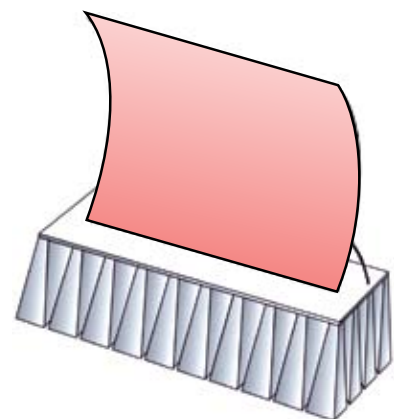

Graphic Dimensions: Refer to Graphic Specifications sheet
Graphic Weight: 2.5 lbs.
Construction: Zippered Pillow Cased FR Photo Fabric® Graphic with Clean Fit Backer.

Items #3530 & #3535

36" x 96"
 Straight Stand Off Frame
 Flat or Vertical Curve (Item #3530)
 Horizontal Curve (Item #3535)

*Stand off can only be used on front side of frame
 *Colored tubing available -see item #3650
 *Cannot be used on Table Top Frames, Sloping Frames, Web Frames or the backside of Double Sided Curved Frames



Frame Dimensions: 36"w x 96"h

Frame Weight: 10.5 Lbs.

Construction: Shock Corded 1.25" Anodized Aluminum Frame With Quick Lock Connectors.

Used With: Flat, Horizontal or Vertical Curved Frames

Item #3583 - 26" x 6" Straight Stand Off Stabilizing Feet

Item #3584 - 16" x 6" Straight Stand Off Stabilizing Feet

Items #3531 & #3532

36" x 96"
 Curved Stand Off Frame
 Flat or Vertical Curve (Item #3531)
 Horizontal Curve (Item #3532)

*Stand off can only be used on front side of frame
 *Colored tubing available -see item #3650
 *Cannot be used on Table Top Frames, Sloping Frames, Web Frames or the backside of Double Sided Curved Frames



Frame Dimensions: 36"w x 96"h

Frame Weight: 10.75 Lbs.

Construction: Shock Corded 1.25" Anodized Aluminum Frame With Quick Lock Connectors.

Used With: Flat, Horizontal or Vertical Curved Frames

Item #3581 - 36" x 6" Curved Stand Off Stabilizing Feet

Item #3582 - 26" x 6" Curved Stand Off Stabilizing Feet

Item #1711



Graphic For 36" x 96"
 Straight Stand Off

Graphic Weight:
 3.5 Lbs.

Item #1715

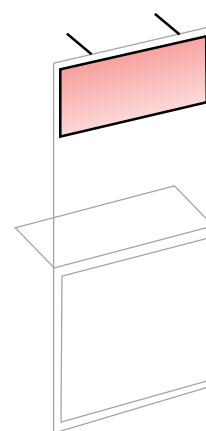

Top Graphic For
 36" x 96" Straight
 Stand Off

Graphic Weight:
 .5 Lbs.

Item #1719

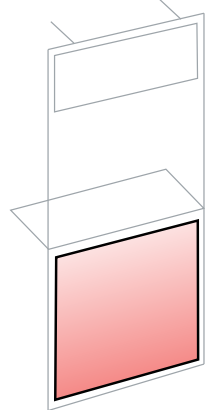

Bottom Graphic For
 36" x 96"
 Straight Stand Off

Graphic Weight:
 1 Lbs.

Construction: Lambda Graphic With Laminate Front And Back*

***Construction Options:** Lambda Clear w/ Matte Front & Gloss Back
 Lambda Flex w/ Textured, Gloss, Or Matte Laminates

Item #1712

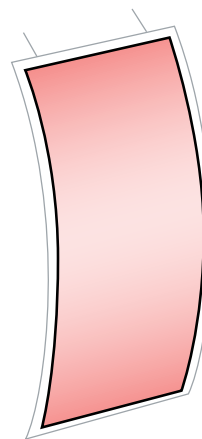

Graphic For 36" x 96"
 Curved Stand Off

Graphic Weight:
 3.5 Lbs.

Item #1716

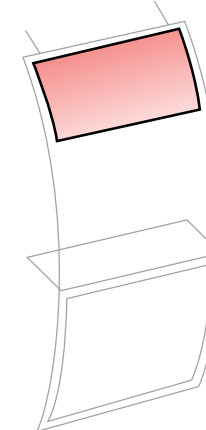

Top Graphic For
 36" x 96" Curved
 Stand Off

Graphic Weight:
 .5 Lbs.

Item #1720

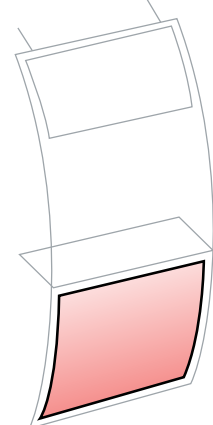

Bottom Graphic For
 36" x 96" Curved
 Stand Off

Graphic Weight:
 1 Lbs.

Construction: Lambda Graphic With Laminate Front And Back*

***Construction Options:** Lambda Clear w/ Matte Front & Gloss Back
 Lambda Flex w/ Textured, Gloss, Or Matte Laminates

Items #3533 & #3536

18" x 96"
 Straight Stand Off Frame
 Flat or Vertical Curve (Item #3533)
 Horizontal Curve (Item #3536)



*Stand off can only be used on front side of frame
 *Colored tubing available -see item #3650
 *Cannot be used on Table Top Frames, Sloping Frames, Web Frames or the backside of Double Sided Curved Frames

Frame Dimensions: 18"w x 96"h
Frame Weight: 9.75 Lbs.
Construction: Shock Corded 1.25" Anodized Aluminum Frame With Quick Lock Connectors.
Used With: Flat, Horizontal or Vertical Curved Frames
 Item #3583 - 26" x 6" Straight Stand Off Stabilizing Feet
 Item #3584 - 16" x 6" Straight Stand Off Stabilizing Feet

Item #1713

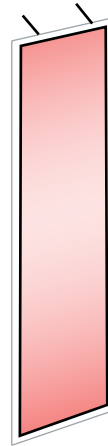

Graphic For 18" x 96" Straight Stand Off

Graphic Weight:
 1.75 Lbs.

Item #1717

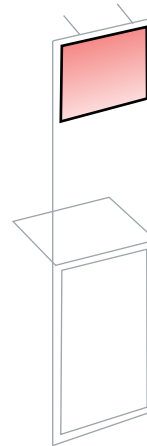

Top Graphic For 18" x 96" Straight Stand Off

Graphic Weight:
 .25 Lbs.

Item #1721

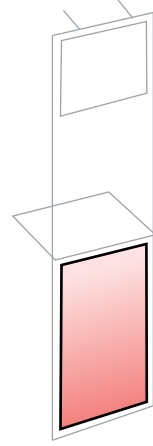

Bottom Graphic For 18" x 96" Straight Stand Off

Graphic Weight:
 .5 Lbs.

Construction: Lambda Graphic With Laminate Front And Back*

***Construction Options:** Lambda Clear w/ Matte Front & Gloss Back
 Lambda Flex w/ Textured, Gloss, Or Matte Laminates

Items #3534 & #3537

18" x 96"
 Curved Stand Off Frame
 Flat or Vertical Curve (Item #3534)
 Horizontal Curve (Item #3537)



*Stand off can only be used on front side of frame
 *Colored tubing available -see item #3650
 *Cannot be used on Table Top Frames, Sloping Frames, Web Frames or the backside of Double Sided Curved Frames

Frame Dimensions: 18"w x 96"h
Frame Weight: 9.75 Lbs.
Construction: Shock Corded 1.25" Anodized Aluminum Frame With Quick Lock Connectors.
Used With: Flat, Horizontal or Vertical Curved Frames
 Item #3581 - 36" x 6" Curved Stand Off Stabilizing Feet
 Item #3582 - 26" x 6" Curved Stand Off Stabilizing Feet

Item #1714

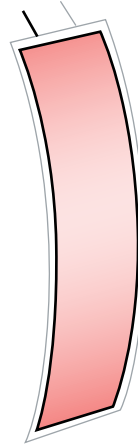

Graphic For 18" x 96" Curved Stand Off

Graphic Weight:
 1.75 Lbs.

Item #1718

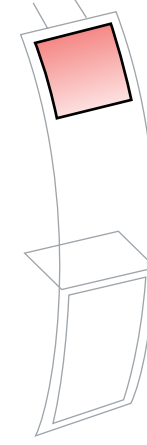

Top Graphic For 18" x 96" Curved Stand Off

Graphic Weight:
 .25 Lbs.

Item #1727

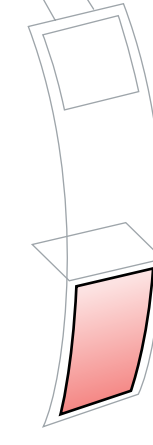

Bottom Graphic For 18" x 96" Curved Stand Off

Graphic Weight:
 .5 Lbs.

Construction: Lambda Graphic With Laminate Front And Back*

***Construction Options:** Lambda Clear w/ Matte Front & Gloss Back
 Lambda Flex w/ Textured, Gloss, Or Matte Laminates

Item #3676

31" x 96"
Horizontal Curve
Stand Off Frame

*Stand off can only be used
on front side of frame
*Colored tubing available
-see item #3650
*Cannot be used on Table Top
Frames, Sloping Frames, Web Frames
or the backside of Double Sided
Curved Frames



Frame Dimensions: 31"w x 96"h

Frame Weight: 11 Lbs.

Construction: Shock Corded 1.25" Anodized Aluminum Frame With
Quick Lock Connectors.

Used With: Wave, Flat, Horizontal Curved or Vertical Curved Frames

Item #1711

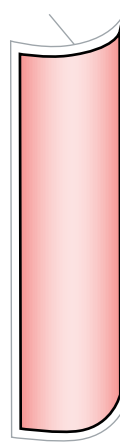

Graphic For 31" x 96"
Horizontal Curve
Stand Off

Graphic Weight:
3.5 Lbs.

Item #1715



Top Graphic For
31" x 96" Horizontal
Curve Stand Off

Graphic Weight:
0.5 Lbs.

Item #1719

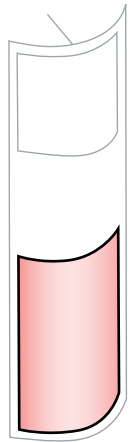

Bottom Graphic For
31" x 96" Horizontal
Curve Stand Off

Graphic Weight:
1 Lbs.

Construction: Lambda Graphic With Laminate Front And Back*

***Construction Options:** Lambda Clear w/ Matte Front & Gloss Back
Lambda Flex w/ Textured, Gloss, Or Matte Laminates

Item #1578

Extended Rear Projection Stand Off



Frame Dimensions: 36" w x 96" h x 29" d
Frame Weight: 11.75 Lbs.
Construction: Shock Corded 1.25" Anodized Aluminum Frame With Quick Lock Connectors
Use With: Item #3677 Large Rear Projection Screen

Item #3677

Large Rear Projection Screen



Screen Dimensions: 27.5" w x 20.625" h (1:1.75 Throw Ratio)
Screen Weight: 5 Lbs.
Construction: Plexiglas Vision 28001 P97 Gray
Use With: Item #1578 Extended Rear Projection Stand Off

Item #3531

Standard Rear Projection Stand Off



Frame Dimensions: 36" w x 96" h x 6" d
Frame Weight: 10.75 Lbs.
Construction: Shock Corded 1.25" Anodized Aluminum Frame With Quick Lock Connectors
Use With: Item #3678 Small Rear Projection Screen

Item #3678

Small Rear Projection Screen



Screen Dimensions: 20" w x 15" h (1:1.75 Throw Ratio)
Screen Weight: 4 Lbs.
Construction: Plexiglas Vision 28001 P97 Gray
Use With: Item #3531 Standard Rear Projection Stand Off

Item #1579

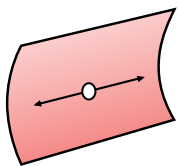

8' x 10'
Rear Projection Graphic

Item #1580

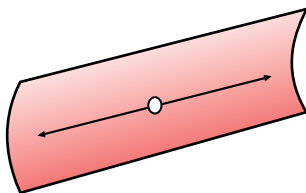

8' x 20'
Rear Projection Graphic

Graphic Dimensions: Refer To Graphic Specifications Sheet
Graphic Weight: 6 Lbs. (8' x 10' Graphic) And 14 Lbs. (8' x 20' Graphic)
Construction: Zippered Pillow Cased FR Photo Fabric® Graphic With Clean Fit Backer And Heat Sealed Projector Opening

Note: Projector Opening Placement Can Be Customized. Please See Graphic Template.

Item #3679

Projector Stand

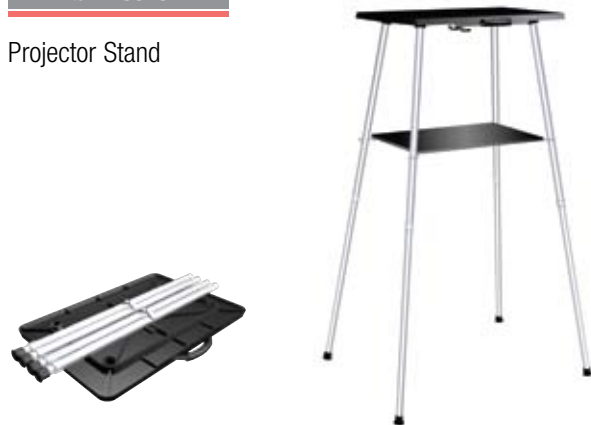

Stand Dimensions: 17" x 25" (Top Shelf) x 32"-56" Adjustable Height
Stand Weight: 9.5 Lbs.
Stand Load Weight: 100 Lbs. Evenly Distributed
Construction: Molded Resin Shelf With Aluminum Alloy Legs And Non Skid Rubber Clad Feet

Item #3640

Header Bracket



Construction: 1.25" Aluminum Tubing With QL Connector And 34" Aluminum Plate with Velcro Strip. **Used With:** Any Frame, Stand Off, Or Header Graphic

Item #1723

47.5" x 11.5"
Large Oval Graphic
For Header Bracket

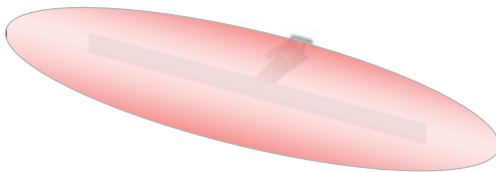

Graphic Dimensions: Refer To Graphic Specifications Sheet
Graphic Weight: 2 Lbs.
Construction: Lambda Graphic* Mounted To 3 Mil Sintra

***Construction Options:** Lambda Paper w/ Textured, Matte, Or Gloss Laminate & Black Or White Sintra

Item #1725

35.5" x 11.5"
Small Oval Graphic
For Header Bracket

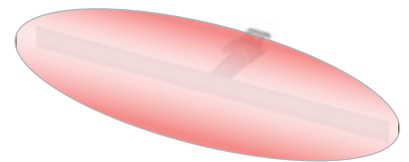

Graphic Dimensions: Refer To Graphic Specifications Sheet
Graphic Weight: 1.5 Lbs.
Construction: Lambda Graphic* Mounted To 3 Mil Sintra

***Construction Options:** Lambda Paper w/ Textured, Matte, Or Gloss Laminate & Black Or White Sintra

Item #1726

47.5" x 11.5"
Large Rectangle Graphic
For Header Bracket

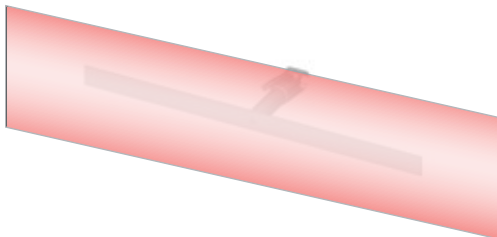

Graphic Dimensions: Refer To Graphic Specifications Sheet
Graphic Weight: 2 Lbs.
Construction: Lambda Graphic* Mounted To 3 Mil Sintra

***Construction Options:** Lambda Paper w/ Textured, Matte, Or Gloss Laminate & Black Or White Sintra

Item #1724

35.5" x 11.5"
Small Rectangle Graphic
For Header Bracket

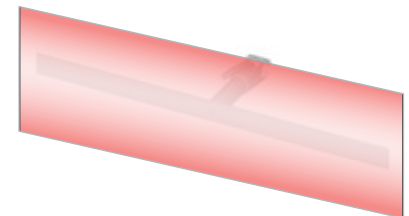

Graphic Dimensions: Refer To Graphic Specifications Sheet
Graphic Weight: 1.5 Lbs.
Construction: Lambda Graphic* Mounted To 3 Mil Sintra

***Construction Options:** Lambda Paper w/ Textured, Matte, Or Gloss Laminate & Black Or White Sintra

Item #3571

40" High Oval Podium / Table

*Colored tubing available
- see item #3650
*Table top will ship separately
from standard case



Table Top Dimensions: 37.5"l x 17.5"w
Podium Weight: 18 Lbs.
Load Weight: 60 Lbs. Evenly Distributed
Construction: White Acrylic Table Top. Frame Is Made From 1.25" Anodized Aluminum And Quick Lock Connectors

Items #1458 & #1582

Graphic For Oval Table (#1458)
Graphic With Zipper Option (#1582)

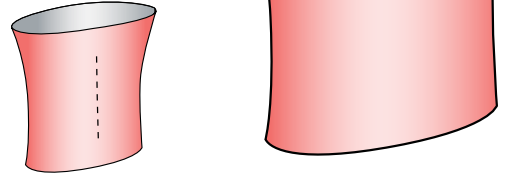

Graphic Dimensions: Refer To Graphic Specifications Sheet (Graphic Template Available)
Graphic Weight: 1 Lbs.
Construction: FR Photo Fabric® Graphic - Pillow cased

Item #3680

40" Curved Podium

*Colored tubing available
- see item #3650
*Table top will ship separately
from standard case



Table Top Dimensions: 27"l x 13.5"w
Podium Weight: 15 Lbs.
Load Weight: 60 Lbs. Evenly Distributed
Construction: White Acrylic Table Top. Frame Is Made From 1.25" Anodized Aluminum And Quick Lock Connectors.

Item #1581

Graphic For Curved Podium

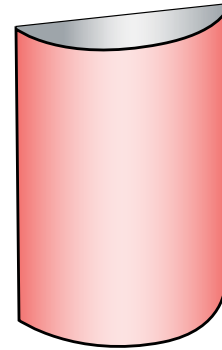

Graphic Dimensions: Refer To Graphic Specifications Sheet (Graphic Template Available)
Graphic Weight: 1 Lbs.
Construction: FR Photo Fabric® Graphic - Open Back

Item #3681

40" Arch Podium

*Colored tubing available
- see item #3650
*Table top will ship separately
from standard case



Table Top Dimensions: 37.5"l x 17.5"w
Podium Weight: 15 Lbs.
Load Weight: 60 Lbs. Evenly Distributed
Construction: White Acrylic Table Top. Frame Is Made From 1.25" Anodized Aluminum And Uses Quick Lock And Hex Wrench Connectors.

Items # 1583 & #1584

Graphic For Arch Podium (#1583)
Graphic With Zipper Option (#1584)

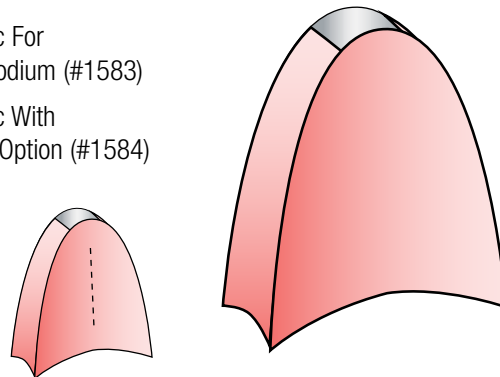

Graphic Dimensions: Refer To Graphic Specifications Sheet (Graphic Template Available)
Graphic Weight: 1 Lbs.
Construction: FR Photo Fabric® Graphic - Pillow cased

Items #3686, #3687, #3688

Pop-up Podium

- Black Table Top (#3686)
- White Table Top (#3687)
- Wood Grain Table Top (#3688)

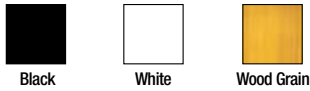

Podium Dimensions: 41.75"l x 15.75"w x 38.5"h
Podium Weight: 25 Lbs.
Podium Load Weight: 25 Lbs. Evenly Distributed
Storage Shelf Load Weight: 7 Lbs. Evenly Distributed
Construction: Collapsible Aluminum Frame With Sure Lock Connectors
 And Velcro Perimeter; Corrugated Plastic Storage Shelf
Packaging: Frame, Shelf And Attached Graphic Ship In Durable Nylon Carrying Bag

Item #1585

Graphic For
Pop-up Podium

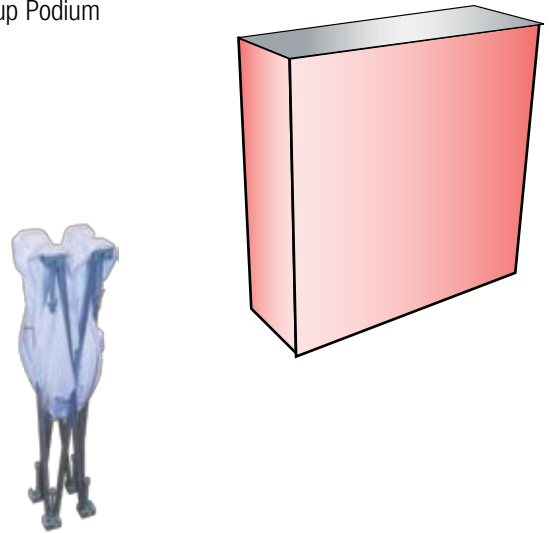

Graphic Dimensions: Refer To Graphic Specifications Sheet
 (Graphic Template Available)
Graphic Weight: 1 Lbs.
Construction: FR Photo Fabric® Graphic With Velcro Perimeter - Open Back

Item #3570

40" High Round Podium/
Table

*Colored tubing available
 - see item #3650



Table Top Dimensions: 24" Diameter
Podium Weight: 12 Lbs.
Load Weight: 40 Lbs. Evenly Distributed
Construction: Clear Acrylic Table Top Folds In Half. Frame Is
 Made From 1.25" Anodized Aluminum And Hex Wrench Connectors.

Item #3572

37.5" Studio Table

*Colored tubing available
 - see item #3650



Table Top Dimensions: 30"l x 20"w
Podium Weight: 18 Lbs.
Load Weight: 60 Lbs. Evenly Distributed
Construction: Clear Acrylic Table Top. 1.25" Anodized
 Aluminum Tubing And Hex Wrench Connectors.

Item #3610

(2) Standard
Frame Lights



Maximum Arm Length: 17"

Light Weight: 1.5 Lbs. Per Pair

Construction: 50 Watt Halogen Adjustable Lamp Telescoping Arms, Tension Screw Clasp Connection & Standard Outlet Plug.

Used With: Any Frame Or Stand Off

Item #3611

(2) Deluxe Frame Lights



Maximum Arm Length: 20"

Light Weight: 1.5 Lbs. Per Pair

Construction: 50 Watt Halogen Adjustable Lamp, 2 Casing Trim Options, Tension Screw Clasp Connection & Standard Outlet Plug.

Used With: Any Frame Or Stand Off

Items #3564 & #3565

Arm & Table
Flat or Horizontal Curve (#3564)
Vertical Curve (#3565)



*Colored tubing available
- see item #3650

Shelf Dimensions: 12" dia.

Shelf Weight: 2.25 Lbs.

Load Weight: 20 Lbs. Evenly Distributed

Construction: Clear Acrylic Shelf 1.25" Anodized Supports And Quick Lock Connectors

Used With: Any Web*, Wave*, Flat, Horizontal Curve or Vertical Curved Frame

*Both Item #3564 & #3565 Will Attach To Web & Wave Frames.

Item #3566

Compact Literature Holder

*Arm and Connector Sold Separately



Shelf Dimensions: 11" dia. x 8"h

Shelf Weight: 2 Lbs.

Load Weight: 20 Lbs. Evenly Distributed

Construction: 11" dia. Clear Acrylic Platform With 3 Removable Aluminum Dividers. Supports Standard Letter And Tri-Fold Literature.

Requires: Item #3564 - Interchangeable Arm & Table
Item #3565 - Interchangeable Arm & Table

Item #3682

Horizontal Curved Stand Off Shelf



Shelf Dimensions: 30"w x 11.75"d
Shelf Weight: 5.5 Lbs.
Load Weight: 50 Lbs. Evenly Distributed
Construction: Clear Acrylic Shelf With 1.25" Anodized Supports and Quick Lock Connectors
Used With: Item #3676 - Horizontal Curved Stand Off

Items #3555 & 3557

36" Stand Off Shelf Pkg.
 Straight Stand Off (#3555)
 Curved Stand Off (#3557)

*Colored tubing available
 see item #3650



Shelf Dimensions: 29.75"w x 12"d
Shelf Weight: 5.5 Lbs.
Load Weight: 100 Lbs. Evenly Distributed
Construction: Clear Acrylic Shelf With 1.25" Anodized Supports and Quick Lock Connectors
Used With: Item #3530 - 36" x 96" Straight Stand Off - FVC
 Item #3535 - 36" x 96" Straight Stand Off - HC
 Item #3531 - 36" x 96" Curved Stand Off - FVC
 Item #3532 - 36" x 96" Curved Stand Off - HC

Items #3556 & #3558

18" Stand Off Shelf Pkg.
 Straight Stand Off (#3556)
 Curved Stand Off (#3558)

*Colored tubing available
 -see item #3650



Shelf Dimensions: 11.75"w x 12"d
Shelf Weight: 3.5 Lbs.
Load Weight: 50 Lbs. Evenly Distributed
Construction: Clear Acrylic Shelf With 1.25" Anodized Supports and Quick Lock Connectors
Used With: Item #3533 - 18" x 96" Straight Stand Off - FVC
 Item #3536 - 18" x 96" Straight Stand Off - HC
 Item #3534 - 18" x 96" Curved Stand Off - FVC
 Item #3537 - 18" x 96" Curved Stand Off - HC

Items #3628 & #3684

Grid Wall Fixture
 36" (#3628)
 18" (#3684)

*Colored tubing available
 -see item #3650

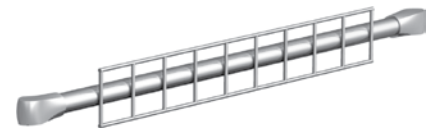

Load Weight: 7 Lbs. Evenly Distributed
Construction: Aluminum Fixture With 3" Grid Wall Sections
Used With: Any 36" Stand Off (#3628)
 or 18" Stand Off (#3684)
 All Grid Wall Accessories



Item #3620

7-Ball Display Hanger

*Requires long stabilization foot

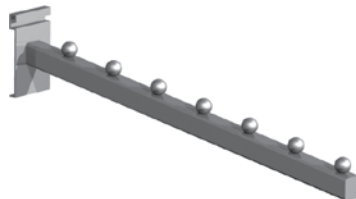

Load Weight: 7 Lbs. Evenly Distributed
Construction: Chrome
Used With: Item #3628 - 36" Grid Wall Fixture
 Item #3684 - 18" Grid Wall Fixture
 Item #3583 - Long Straight Stabilizing Feet
 Item #3581 - Long Curved Stabilizing Feet

Item #3627

Faceout Square – 12"

*Requires short stabilization foot

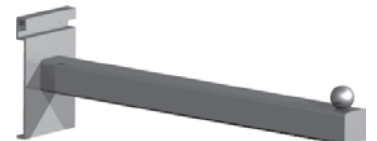

Load Weight: 7 Lbs. Evenly Distributed
Construction: Chrome
Used With: Item #3628 - 36" Grid Wall Fixture
 Item #3684 - 18" Grid Wall Fixture
 Item #3584 - Short Straight Stabilizing Feet
 Item #3582 - Short Curved Stabilizing Feet

Item #3621

Display Hook – 12"

*Requires short stabilization foot



Load Weight: 2 Lbs. Evenly Distributed

Construction: Chrome

Used With: Item #3628 - 36" Grid Wall Fixture
 Item #3684 - 18" Grid Wall Fixture
 Item #3584 - Short Straight Stabilizing Feet
 Item #3582 - Short Curved Stabilizing Feet

Item #3622

Acrylic Shelf – 6" x 12"

*Requires short stabilization foot



Load Weight: 2 Lbs. Evenly Distributed

Construction: Clear Acrylic

Used With: Item #3628 - 36" Grid Wall Fixture
 Item #3684 - 18" Grid Wall Fixture
 Item #3584 - Short Straight Stabilizing Feet
 Item #3582 - Short Curved Stabilizing Feet

Item #3623

Acrylic Shelf – 12" x 16"

*Requires long stabilization foot

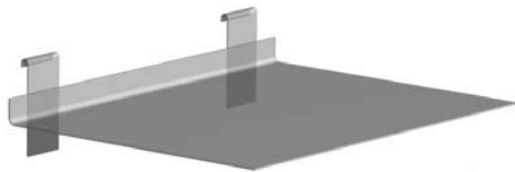

Load Weight: 2 Lbs. Evenly Distributed

Construction: Clear Acrylic

Used With: Item #3628 - 36" Grid Wall Fixture
 Item #3684 - 18" Grid Wall Fixture
 Item #3583 - Long Straight Stabilizing Feet
 Item #3581 - Long Curved Stabilizing Feet

Item #3624

Acrylic Tray – 8" x 12" x 2"

*Requires short stabilization foot

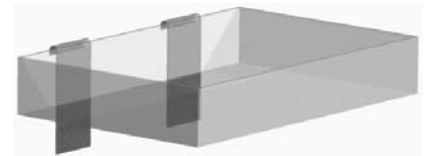

Load Weight: 2 Lbs. Evenly Distributed

Construction: Clear Acrylic

Used With: Item #3628 - 36" Grid Wall Fixture
 Item #3684 - 18" Grid Wall Fixture
 Item #3584 - Short Straight Stabilizing Feet
 Item #3582 - Short Curved Stabilizing Feet

Item #3625

Shoe Toe Hold – 7" x 10"

*Requires short stabilization foot



Load Weight: 2 Lbs. Evenly Distributed

Construction: Clear Acrylic

Used With: Item #3628 - 36" Grid Wall Fixture
 Item #3684 - 18" Grid Wall Fixture
 Item #3584 - Short Straight Stabilizing Feet
 Item #3582 - Short Curved Stabilizing Feet

Item #3626

Slant With Lip – 14" x 22.5"

*Requires long stabilization foot

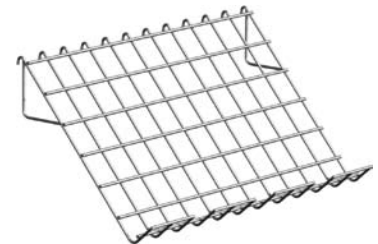

Load Weight: 2 Lbs. Evenly Distributed

Construction: Chrome

Used With: Item #3628 - 36" Grid Wall Fixture
 Item #3684 - 18" Grid Wall Fixture
 Item #3583 - Long Straight Stabilizing Feet
 Item #3581 - Long Curved Stabilizing Feet

Item #3584

(2) Short Straight Stand Off Stabilizing Feet

*Colored tubing available
-see item #3650



Dimensions: 6"w x 16"d
Construction: Aluminum
Used With: Any Straight Stand Off

Item #3582

(2) Short Curved Stand Off Stabilizing Feet

*Colored tubing available
-see item #3650



Dimensions: 6"w x 26"d
Construction: Aluminum
Used With: Any Curved Stand Off

Item #3583

(2) Long Straight Stand Off Stabilizing Feet

*Colored tubing available
-see item #3650



Dimensions: 6"w x 26"d
Construction: Aluminum
Used With: Any Straight Stand Off

Item #3581

(2) Long Curved Stand Off Stabilizing Feet

*Colored tubing available
-see item #3650



Dimensions: 6"w x 36"d
Construction: Aluminum
Used With: Any Curved Stand Off

Items #3608 & #3683

Horizontal Stand Off Monitor Attachment
36" (#3608)
18" (#3683)

*VESA 75 x 75 Or 100 x 100 Compatible
*Colored tubing available
-see item #3650
*Requires Stabilizing feet



Construction: 1.25" Anodized Aluminum Tubing Connected To VESA 75 x 75 Or 100 x 100 Mounting Bracket
Used With: Any 36" (#3608) or 18" (#3683) Straight Or Curved Stand Off

* Monitor Cannot Exceed 29.5" Wide.
* Customer Responsible For Attaching Monitor Cords & Cables To The Exterior Of The Stand Off.

Items #3605 & 3606

Flat Panel Monitor Stand Off Attachment
30" (#3606)
18" (#3605)

*VESA 75 x 75 Or 100 x 100 Compatible
*Colored tubing available
-see item #3650
*Requires Stabilizing feet



Construction: 1.25" Anodized Aluminum Tubing Connected To VESA 75 x 75 Or 100 x 100 Mounting Bracket
Used With: Any 36" Straight Or Curved Stand Off

* Monitor Cannot Exceed 29.5" Wide.
* Customer Responsible For Attaching Monitor Cords & Cables To The Stand Off.

Item #3615

Entasi Travel Case (Large)



Case Dimensions: 53"l x 25.5"w x 10"d (ID)
55"l x 27.5"w x 11"d (OD)

Case Weight: 34 Lbs.

Construction: Black Roto Molded Case with Handles, Wheels And Removable Lid.

Item #3616

Entasi Travel Case (Small)



Case Dimensions: 52.5"l x 15"w x 12.5"d (ID)
54.5"l x 17"w x 13.5"d (OD)

Case Weight: 22.25 Lbs.

Construction: Black Roto Molded Case with Handles, Wheels And Removable Lid.

Item #3656

Replacement Hex Tool



Quantity: 1 Tool
Description: .25" Hex Wrench

Item #3650

Standard Powder Coating Color Options

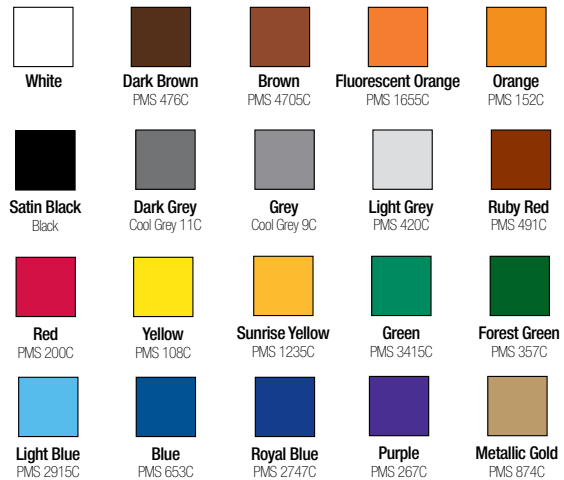

* PMS Colors are approximate. Actual color may vary.

Item #3651

Custom Powder Coating Color Options

*Please call for color options.



1-888-EXHIBIT
(1-888-394-4248)
displayHQ.com