

EZ TRUSS Truss System

Portable



**Easy
NO TOOL
Setup**



Versatile

**Custom
Results**

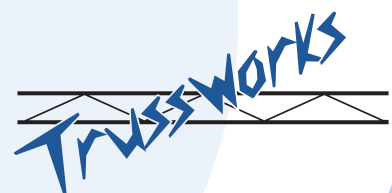



Truss System



- Fully collapsible, fits in 4' panel cases and saves on shipping!
- Sets up in minutes without tools, and only ONE wingnut per 8' leg!
- Preconfigured truss can easily be reconfigured for exhibiting versatility.
- Unlimited merchandising possibilities.
- Magnetic Graphics adhere instantly onto Steel Square Tube Truss.
- Graphic services and additional mounts and accessories are available.

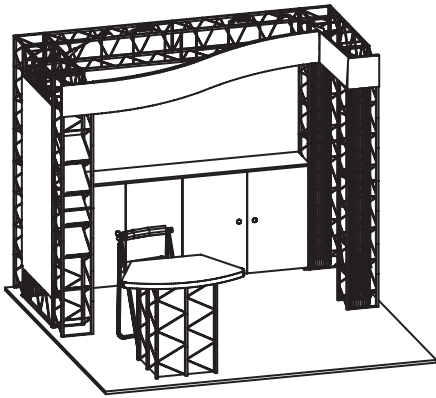

EZ12 Kit #A10 - 10 x 10 \$5,787

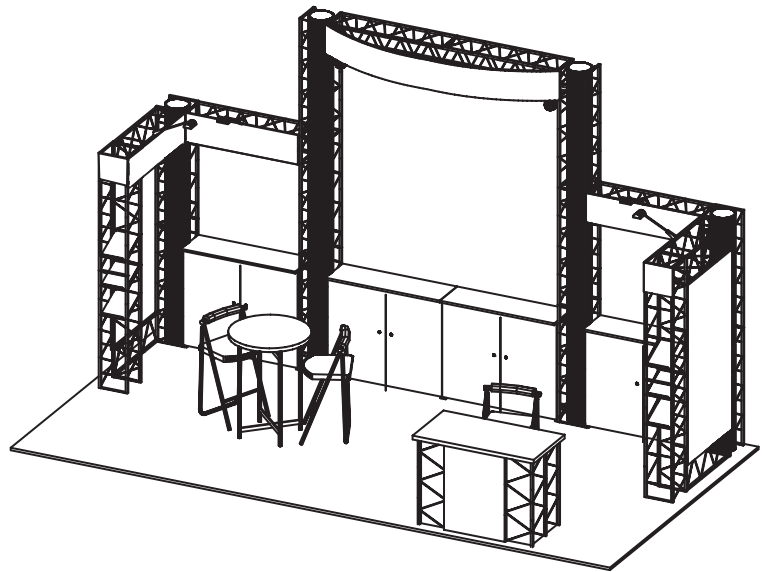

EZ12 Kit #D20 - 10 x 20 \$9,938

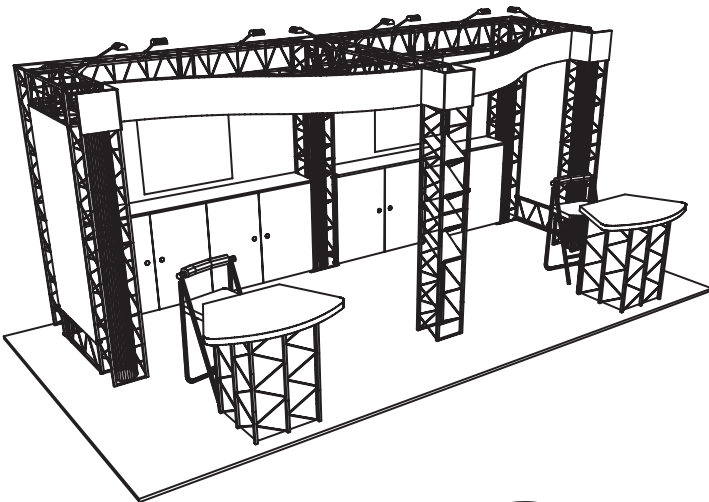

EZ12 Kit #A20 - 10 x 20 \$10,184

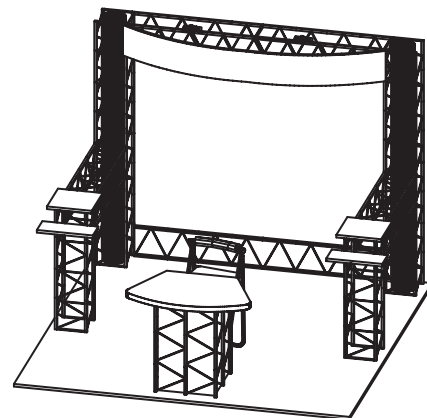

EZ12 Kit #C10 - 10 x 10 \$4,610

Pricing does not include freestanding counters or furniture.
Graphics, Computers, Monitors, and A/V equip. available at an additional charge.



Truss System



- Fully collapsible, fits in 4' panel cases and saves on shipping!
- Sets up in minutes without tools, and only ONE wingnut per 8' leg!
- Preconfigured truss can easily be reconfigured for exhibiting versatility.
- Unlimited merchandising possibilities.
- Magnetic Graphics adhere instantly onto Steel Square Tube Truss.
- Graphic services and additional mounts and accessories are available.

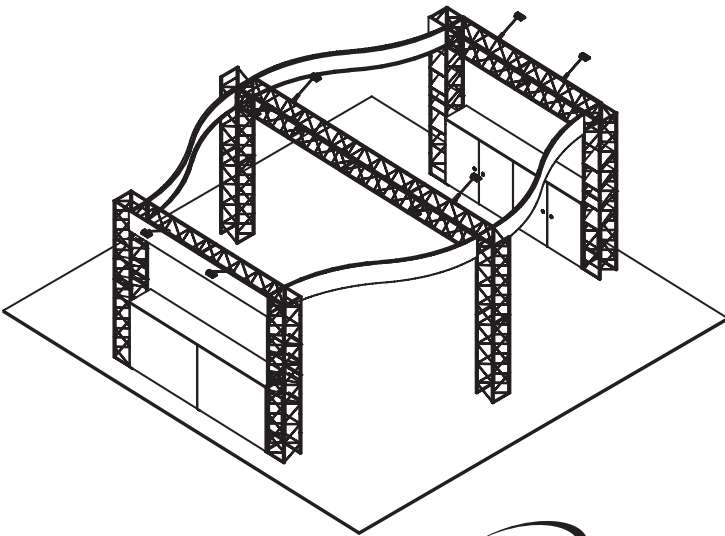

EZ12 Kit #5 - 20 x 20 \$11,579

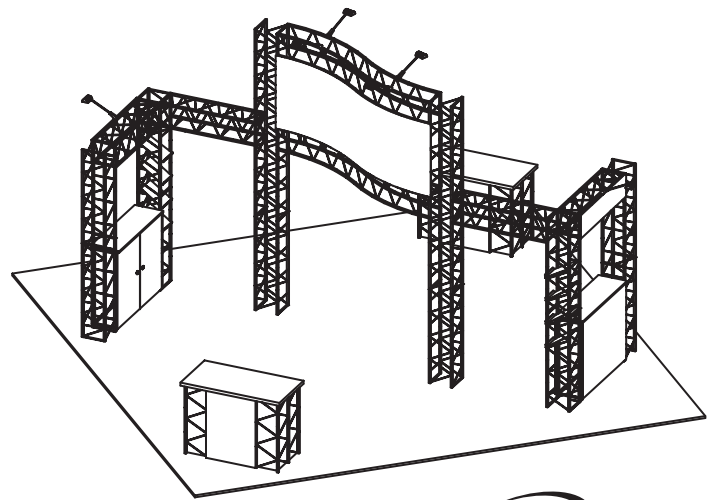

EZ12 Kit #6 - 20 x 20 \$9,245

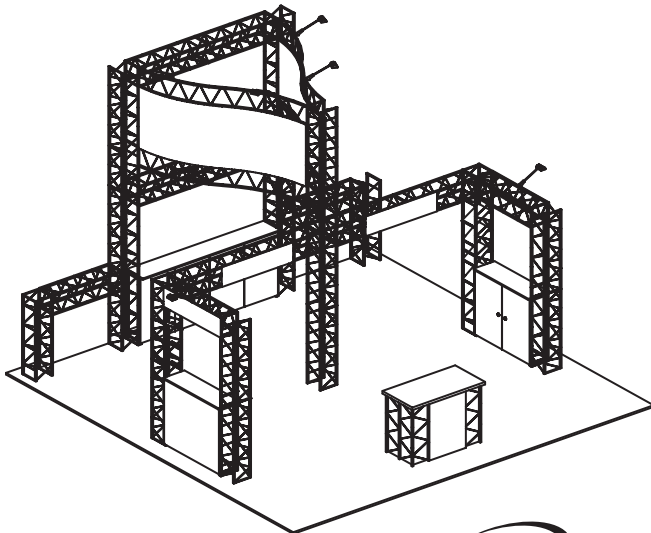

EZ12 Kit #7 - 20 x 20 \$13,548

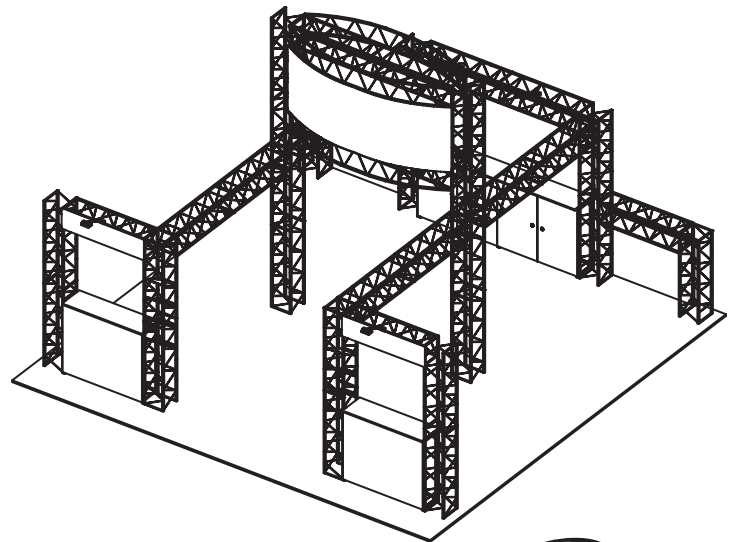

EZ12 Kit #8 - 20 x 20 \$14,743

Pricing does not include freestanding counters or furniture.
Graphics, Computers, Monitors, and A/V equip. available at an additional charge.



EZ12 ~ Parts

Fully collapsible, 11.5", steel 3/4" square tube, modular truss
All pieces are powdercoated, Custom items available

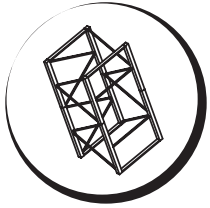

EZ 12 Standard Lengths

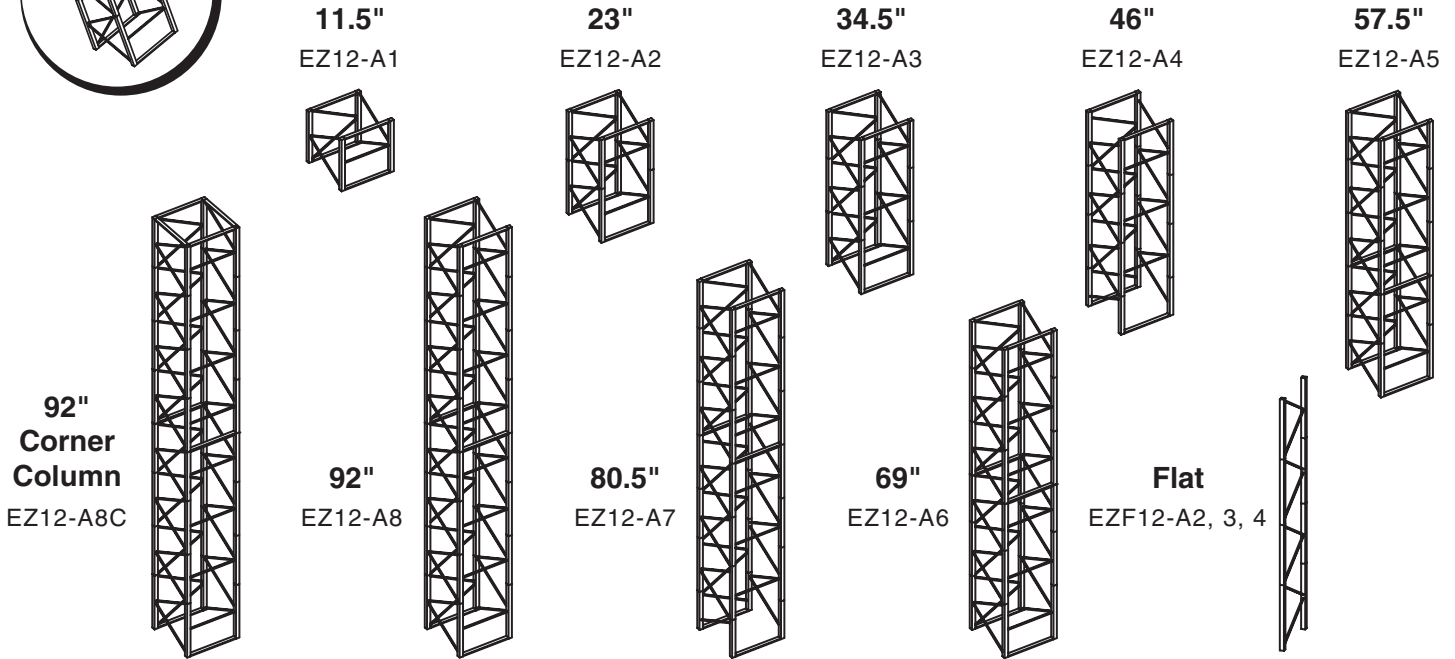

All lengths over 4' fold in half to fit in a standard exhibit case!
Please refer to the demonstration on page 8.

EZ 12 Curve

57 1/2" radius
45° section.

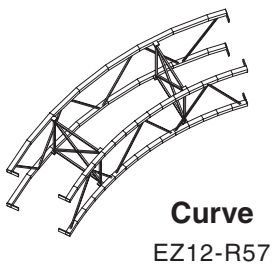

EZ 12 Small Shelves

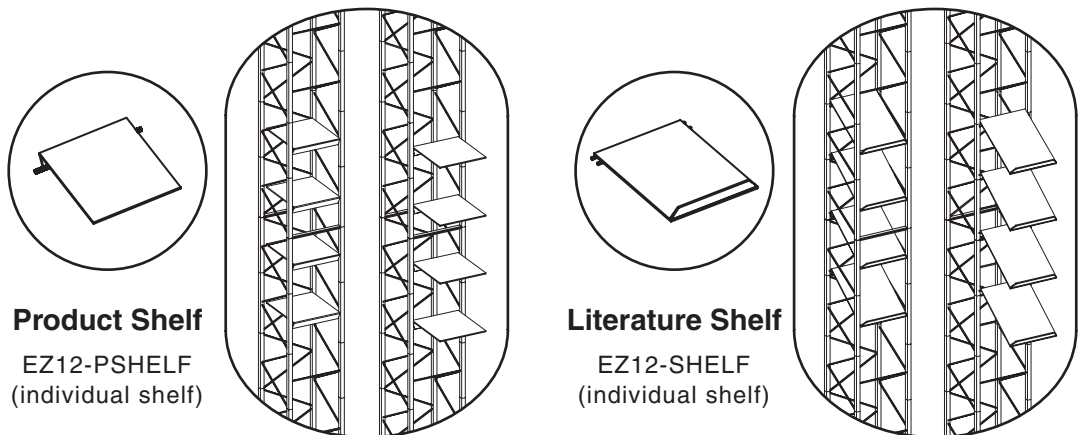

Shelves can be configured to the interior or exterior of truss.

EZ 12 ~ Parts

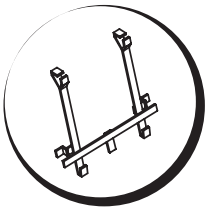

EZ 12 Connection System

Corner Connector A
EZ12-CCA

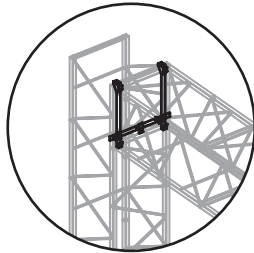
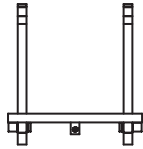

CCA: Use these to attach a horizontal truss to the very top of a vertical truss on the ladder side, (the side you can put collateral shelves into) or the side opposite the ladder side.

Corner Connector B
EZ12-CCB

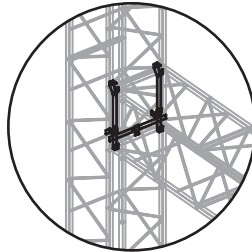
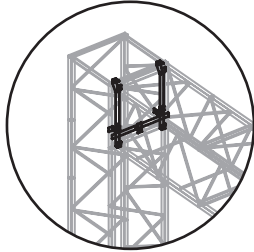
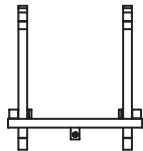

CCB: Used to attach a horizontal truss to the top of the OTHER 2 sides of a vertical truss. (Truss adjacent to the sides a CCA would connect to.)

Using one of these you can also attach a horizontal truss at a junction in the vertical truss on the ladder side (or the side opposite the ladder side.)

Corner Connector C
EZ12-CCB

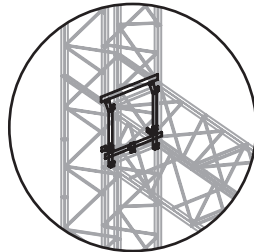
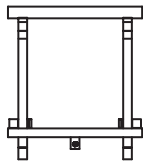

CCC: Use this for horizontal trusses being attached to vertical truss, at a junction, on the sides ADJACENT to the ladder side.

Corner Connector D
EZ12-CCB

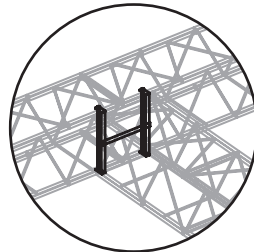
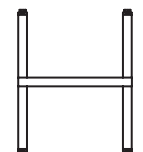

CCD: Use this to attach a horizontal truss to another horizontal truss - anywhere along the span.

Rotating Curve
5° - 90°
EZ12-ADJC

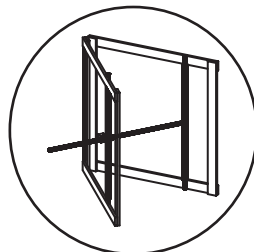
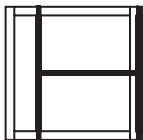

Square Baseplate
EZ12-BASE

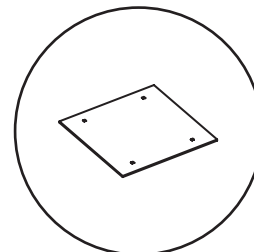

displayHQ Discount Sales: 1-423-952-0770
sales@displayHQ.com | www.displayHQ.com

EZ 12 ~ Parts



EZ 12 Curved Header

Curve or Wave style, accommodates flexible graphic 11.5"H x 100"W.

Ribbon Header ~

EZ12-HDR

Introducing New EZ12 System

Brought to you by 

EZ 12 Counter and Storage Units ~

Counter Unit

EZ12-BWCT4

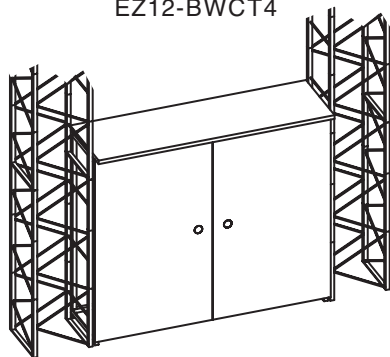

Counter Unit

EZ12-BWCT3

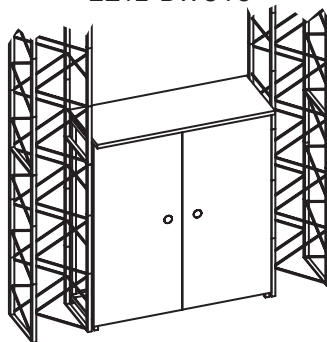

Counter Unit

EZ12-BWCT2

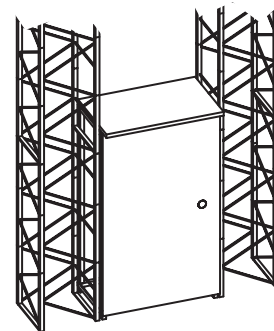

May be configured against a backwall, between columns, or standalone with one column.

Available in 2', 3' and 4' lengths. Counters may be combined for additional length.

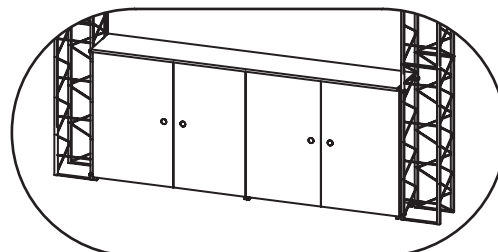

EZ12-BWCT4 (2 side by side)

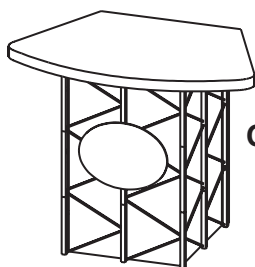

Freestanding Counter Unit 22

EZ12-CT22

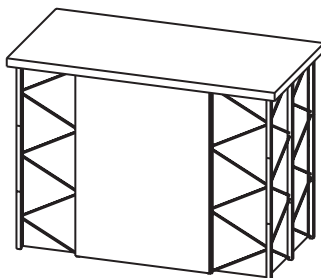

Freestanding Counter Unit 24

EZ12-CT24

Gridwall, shelving, retail hanging and merchandising accessories are available.

displayHQ Discount Sales 1-423-952-0770
sales@displayHQ.com | www.displayHQ.com

~ Graphics not included

Custom graphic "Skins" available at additional charge - Includes magnetized perimeter

EZ 12 ~ Parts



EZ 12 Media Accessories *

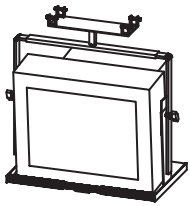

TV mount
EZ12-2030

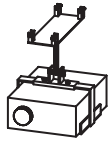

Projector mount
EZ12-PROJ

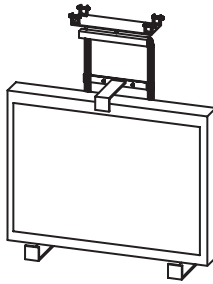

Plasma mount
EZ12-PLASMA

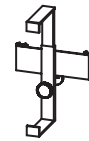

LCD mount
EZ12-LCD

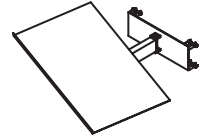

Swivel Keyboard Shelf
EZ12-KBRD

Pack Stuff furniture

Fits into standard exhibit case, powdercoated steel to match truss.

Director's (sling) style chair also available. Please contact us for additional literature and options.

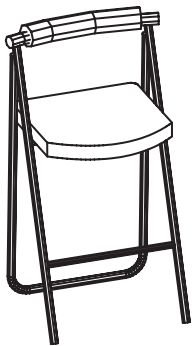

Curved Back Pack Stool
PS-CURVED

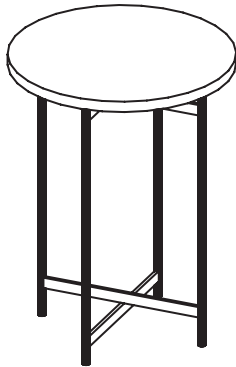

Bar Height Pack Table (30\"/>



Curved Back Pack Chair
PC-CURVED



Standard Pack Table (36\"/>

EZ 12 Arm Light

150W Halogen Lamp
Hood rotates and swivels,
mount adjusts to wall or truss
structure 1/2" - 1" thick.

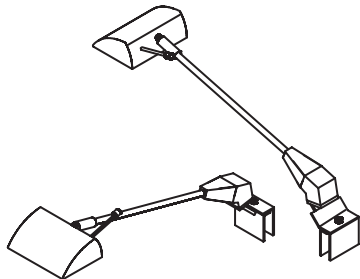

Arm Light
150WW24

Cases for packing

Made of Durable Polyethylene, available with or without casters.

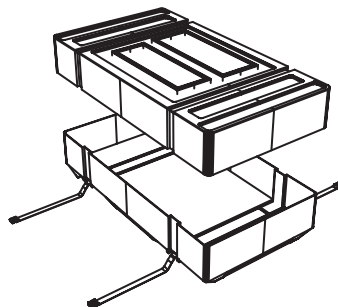

Exterior dimensions:
Model UF4825: 44" x 27" x 10"-16" high
Model UF4331: 44" x 32" x 10"-16" high

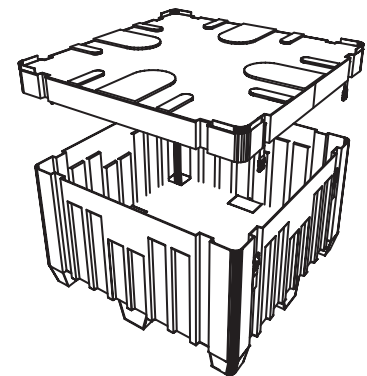

Exterior dimensions:
Model UF4848: 51.5" x 51.5" x 30.5"-33.5" high

* Media not included



EZ 12 Truss System



- Fully collapsible, fits in 4' panel cases and saves on shipping!
- Sets up in a matter of minutes without tools, and only ONE nut per 8' leg!
- Preconfigured truss can easily be reconfigured for exhibiting versatility.
- Unlimited merchandising possibilities.
- Magnetic Graphics adhere instantly onto Steel Square Tube Truss.
- Graphic services and additional mounts and accessories are available.

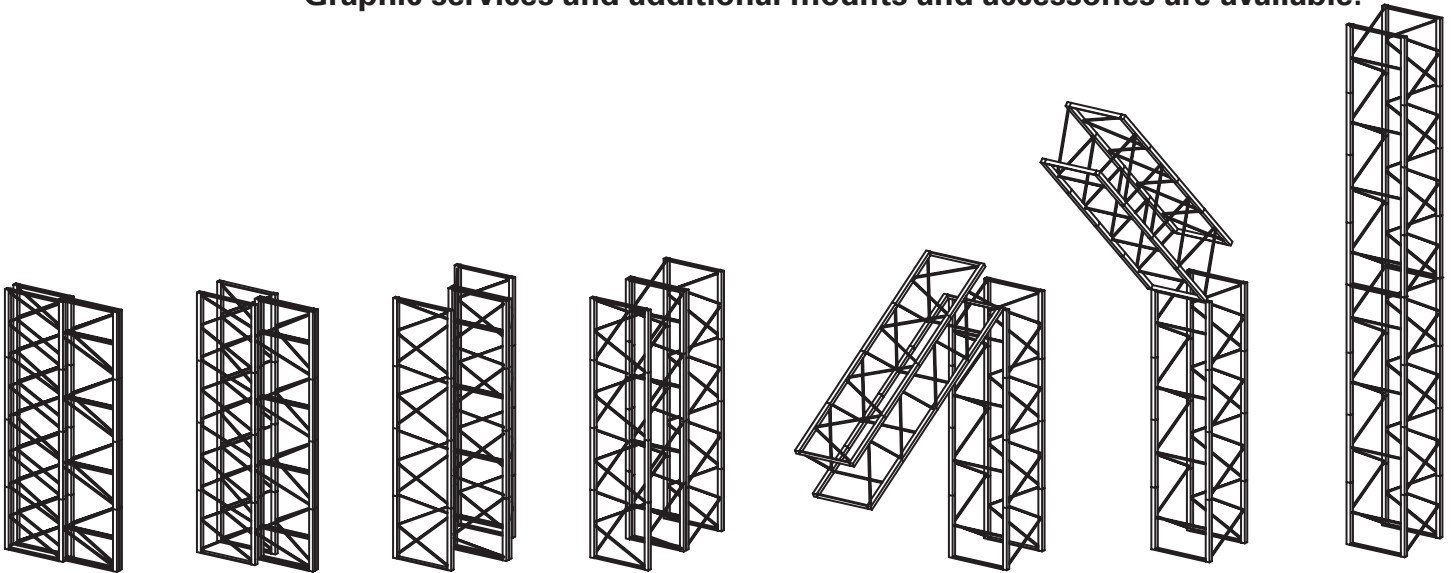

SETS UP IN MINUTES - NO TOOLS REQUIRED!

***Fastest exhibit truss system assembly on the market today
JUST FOLD AND FLIP!***

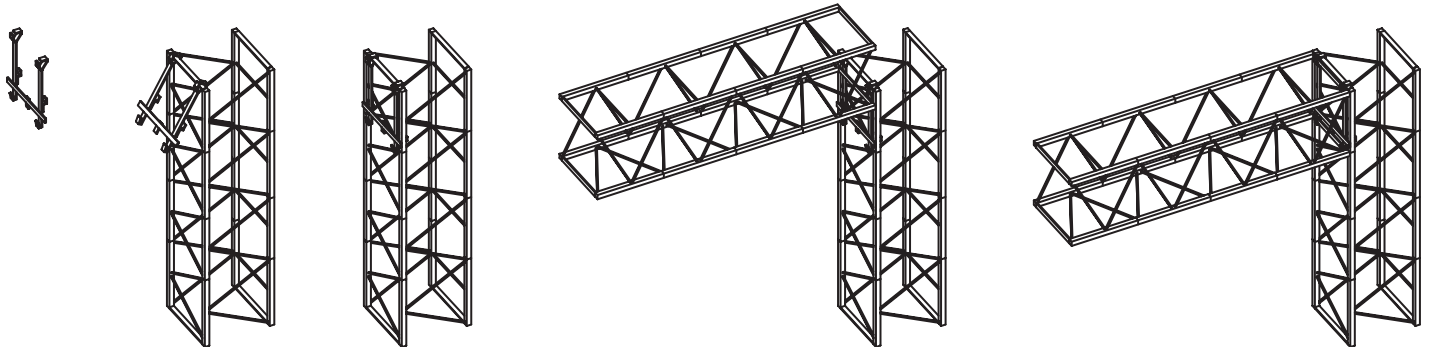

Featuring "EZ CONNECT" corners

